



European Technical Assessment

ETA 22/0616
of 28.10.2022



General part

Technical Assessment Body issuing the ETA: ITeC	
ITeC has been designated according to Article 29 of Regulation (EU) No 305/2011 and is member of EOTA (European Organisation for Technical Assessment)	
Trade name of the construction product	Serie Trebe
Product family to which the construction product belongs	21 – Internal partition kits for use as non-loadbearing walls
Manufacturer	SITAB SYSTEM S.L.U. Parque Empresarial Itziar-Deba, Parcela 12-2 ES 20829 Itziar-Deba (Gipuzkoa) España
Manufacturing plant(s)	Parque Empresarial Itziar-Deba, Parcela 12-2 ES 20829 Itziar-Deba (Gipuzkoa) España
This European Technical Assessment contains	27 pages including 3 annexes which form an integral part of this assessment.
This European Technical Assessment is issued in accordance with Regulation (EU) 305/2011, on the basis of	European Assessment Document 210005-00-0505 <i>Internal partition kits for use as non-loadbearing walls</i> . Edition March 2019.

General comments

Translations of this European Technical Assessment in other languages shall fully correspond to the original issued document and should be identified as such.

Communication of this European Technical Assessment, including transmission by electronic means, shall be in full (excepted the confidential Annex(es) referred to above). However, partial reproduction may be made, with the written consent of issuing Technical Assessment Body. Any partial reproduction has to be identified as such.

Specific parts of the European Technical Assessment

1 Technical description of the product

Serie Trebe internal partition kit for use as non-loadbearing walls is assembled from the following standard modular units:

- ST-100: Frameless single glass walls.
- ST-200: Frameless double glass walls.
- ST-300: Solid walls.
- ST-305: Solid walls with multiple panels in vertical.
- ST-310: Solid walls with horizontal panels.

Serie Trebe internal partition kit also includes the following ancillary modular units:

- ST-340: Technical modules.
- ST-400: Solid doors.
- ST-415: Framed single glass doors.

Metal frame is made of pre-lacquered and galvanized steel (according to EN 10240) horizontal floor and ceiling guides with positionings for vertical uprights every 50 mm. Vertical uprights consist of a bottom telescopic leveller and a telescopic extension, made of galvanized steel.

For glazed units, aluminium (according to EN 573-3) vertical profiles and horizontal guides are assembled upon the metal frame, to allow for the fitting of glazed panels.

The frame is connected to the building structure by means of plastic anchors and self-drilling screws.

Solid¹ panels are made of 19 mm thick particle-board panels with melamine finishing coating and bordered with ABS² edges.

Solid panels are hung on both sides of the framework by means of galvanized hardened steel clips. Additional horizontal steel profiles are placed between the vertical uprights at the horizontal joints between solid panels in standard modular units ST-305 and ST-310.

An insulation board made of mineral wool can be placed between the solid panels. Threaded rods can be placed horizontally between vertical uprights to support the mineral wool panels.

Glazed units consist of laminated safety glasses VSG 55.1, VSG 66.1 and VSG 66.1 Silence according to EN ISO 12543-2 and EN 14449.

Joints between glasses are made by means of transparent adhesive tape.

The walls can be equipped with single or double-leaf doors.

It is possible to combine modular units between solid and glazed series due to the compatibility criteria.

The list of standard modular units of Serie Trebe internal partition kit, including its dimensions, is shown in Annex 1.

The list of the components is shown in Annex 2.

Solutions and construction details are shown in Annex 3.

¹ The terms "solid partitions" and "glazed partitions" are defined in EAD 210005-00-0505.

² ABS: Acrylonitrile butadiene styrene.

2 Specification of the intended use(s) in accordance with the applicable European Assessment Document (hereinafter EAD)

Serie Trebe internal partition kit is intended to be used as immovable and relocatable non-loadbearing partitions under the following conditions:

- Fastened to structures capable of giving adequate support and adequate possibilities for fixing.
- A mean air temperature in the range from 5 °C to 35 °C with a minimum of 0 °C and a maximum of 50 °C.
- A mean daily air relative humidity in the range from 20 % RH to 75 % RH with a maximum air relative humidity only exceeding 85 % RH for short periods of time.
- Use category up to use category IV, which corresponds to area category C5 and area categories A, B, C1 to C4 and D1 to D2 where the partition has the function of a barrier.

Use categories and area categories according to EAD 210005-00-0505 and EN 1991-1-1 – Eurocode 1, respectively.

- Use category IV corresponds to zones accessible primarily to users with little incentive to exercise care. Risk of accidents occurring and of misuse. In case of failure, risk includes the fall to a floor at a lower level.
- Area categories correspond to:
 - A: Areas for domestic and residential activities.
 - B: Office areas.
 - C1 to C4: Areas where people may congregate.
 - C5: Areas susceptible to large crowds.
 - D1 to D2: Shopping areas.
- Zones where surface requirements with respect to hygiene, air quality, static electricity, etc., are of the same nature and magnitude as those in dwellings, offices, schools, institutions, etc.

The provisions made in this ETA are based on an assumed working life of at least 25 years for Serie Trebe internal partition kit. These provisions are based upon the current state of the art and the available knowledge and experience.

The indications given on the working life cannot be interpreted as a guarantee given by the producer, but are to be regarded only as a means for choosing the right products in relation to the expected economically reasonable working life of the works.

3 Performance of the product and reference to the methods used for its assessment

The assessment of Serie Trebe internal partition kit for the intended use was performed following the EAD 210005-00-0505 *Internal partition kits for use as non-loadbearing walls*.

Performance of Serie Trebe internal partition kit is shown in Table 3.1.

Table 3.1: Performance of Serie Trebe internal partition kit.

Basic Works Requirement	ETA section	Essential characteristic	Performance
BWR 2 Safety in case of fire	3.1	Reaction to fire	See section 3.1
	3.2	Resistance to fire	See section 3.2
BWR 3 Hygiene, health and the environment	---	Content, emission and/or release of dangerous substances	No performance assessed
	---	Water vapour permeability	Not relevant
	3.3	Sill height	700 mm See section 3.3
	3.3	Resistance to damage and functional failure from horizontal loads	See section 3.3
	---	Resistance to damage and functional failure from eccentric vertical loads	No performance assessed
	3.4	Resistance to horizontal linear static loads	See section 3.4
	BWR 4 Safety and accessibility in use	---	Resistance to functional failure from point loads parallel or perpendicular to the surface
---		Rigidity of partitions to be used as a substrate for ceramic tiling	Not relevant
---		Safety against personal injuries by contact	No performance assessed
---		Resistance to deterioration caused by: <ul style="list-style-type: none"> – physical agents – chemical agents – biological agents 	No performance assessed
BWR 5 Protection against noise	3.5	Airborne sound insulation	See section 3.5
	---	Sound absorption	No performance assessed
BWR 6 Energy economy and heat retention	---	Thermal resistance	No performance assessed
	---	Thermal inertia	No performance assessed

3.1 Reaction to fire

The individual kit components satisfy the requirements for performance class A1 of reaction to fire, in accordance with the provisions of EC Decision 96/603/EC (as amended) without the need for testing on the basis of that Decision. The following table shows their classification:

Table 3.1.1: Reaction to fire of individual kit components.

Individual kit component	Specification	Reaction to fire class according to EN 13501-1
Aluminium profiles	See Annex 2	A1
Steel profiles	See Annex 2	A1
Glass panels	Glass panes of laminated safety glasses as specified in Annex 2	A1

The following table shows the classification achieved for the standard modular units.

Table 3.1.2: Reaction to fire class according to EN 13501-1.

Standard modular unit	Reaction to fire class according to EN 13501-1
ST-300	
ST-305	D-s1,d0 ⁽¹⁾
ST-310	

Notes:

⁽¹⁾ The reaction to fire class is applicable to standard modular units with the "White W980 ST2" wall covering and with an insulation board made of 50 mm mineral wool panels with a density of 70 kg/m³.

3.2 Resistance to fire

Resistance to fire has been assessed by testing according to EN 1364-1 and classified according to EN 13501-2. The following table shows the classification obtained:

Table 3.2.1: Resistance to fire class according to EN 13501-2.

Standard modular unit	Resistance to fire class according to EN 13501-2
ST-100	
ST-200	No performance assessed
ST-300	EI 45 ⁽¹⁾
ST-305	
ST-310	No performance assessed

Notes:

⁽¹⁾ The resistance to fire class is applicable to standard modular units with an insulation board made of CONLIT 150 P mineral wool panels, or equivalent rock wool panels (50 mm thick panels with a density of 180 kg/m³, and a reaction to fire class A1), with threaded rods between vertical uprights to support the insulation panels.

3.3 Resistance to damage and functional failure from horizontal loads

3.3.1 Resistance to damage and functional failure from soft body impact loads – 50 kg bag

Resistance to structural damage and functional failure from soft body impact loads has been assessed by testing, following the test procedures described in the EAD 210005-00-0505, Annex E, with amendments and modifications as described in Annex A and Annex B.

Table 3.3.1.1: Resistance to damage and functional failure from soft body impact loads.

Standard modular unit ⁽¹⁾	Use category and energy level ⁽²⁾	
	Resistance to structural damage	Resistance to functional failure
ST-100	IVc ⁽³⁾ 900 N·m	IV 120 N·m
ST-200	IVc ⁽³⁾ 900 N·m	IV 120 N·m
ST-300	IVb 500 N·m	IV 120 N·m
ST-305	IVb 500 N·m	IV 120 N·m
ST-310	No performance assessed	

Notes:

⁽¹⁾ An ancillary modular unit ST-340 was included in all tested standard modular units. Impacts were also performed on this ancillary modular unit, proving that it can also be considered class IV.

⁽²⁾ Use category according to EAD 210005-00-0505, Table B.3 and Table B.4.

⁽³⁾ Sill height considered of 700 mm.

3.3.2 Resistance to damage and functional failure from hard body impact loads – 0,5 kg and 1 kg steel ball

Resistance to structural damage and functional failure from hard body impact loads has been assessed by testing, following the test procedures described in the EAD 210005-00-0505, Annex E, with amendments and modifications as described in Annex A and Annex B.

Table 3.3.2.1: Resistance to damage and functional failure from hard body impact loads.

Standard modular unit ⁽¹⁾	Use category and energy level ⁽²⁾	
	Resistance to structural damage	Resistance to functional failure
ST-100	IV 10 N·m	IV 6 N·m
ST-200	IV 10 N·m	IV 6 N·m
ST-300	IV 10 N·m	IV 6 N·m
ST-305	IV 10 N·m	IV 6 N·m
ST-310	No performance assessed	

Notes:

⁽¹⁾ An ancillary modular unit ST-340 was included in all tested standard modular units. Impacts were also performed on this ancillary modular unit, proving that it can also be considered class IV.

⁽²⁾ Use category according to EAD 210005-00-0505, Table B.1 and Table B.2.

3.4 Resistance to horizontal linear static loads

Resistance to horizontal linear static loads has been assessed by testing, following the procedures described in the Annex B.5 of the EAD 210005-00-0505.

Table 3.4.1: Resistance to horizontal linear static loads.

Standard modular unit	Maximum load at a deflection of 40 mm [kN]	Characteristic resistance [kN/m]	Safety factor
ST-100	1,26	0,126	5
ST-200			
ST-300			
ST-305		No performance assessed	
ST-310			

3.5 Airborne sound insulation

Airborne sound insulation has been assessed by testing, following the test procedures described in EN ISO 10140-2. Weighted airborne sound insulation index, R_w (C;C_{tr}), and A spectrum weighted airborne sound insulation index, R_A , as defined in EN ISO 717-1 and EN ISO 140-3, is shown in the following table:

Table 3.5.1: Airborne sound insulation.

Standard modular unit	Weighted airborne sound insulation index	
	R_w (C;C _{tr}) [dB]	With A spectrum weighting, R_A [dBA]
ST-100	-	-
Laminated safety glass VSG 66.1	36 (-2; -3)	34,9
ST-200	-	-
Laminated safety glass VSG 55.1	42 (-2; -6)	40,7
Laminated safety glass VSG 66.1	44 (-2; -6)	43,5
Laminated safety glass VSG 66.1 Silence	46 (-2; -5)	45
ST-300	-	-
Without insulation	38 (-2; -5)	37
With insulation ⁽¹⁾	46 (-3; -9)	43,7
With insulation and an acoustic mesh ⁽²⁾	48 (-4; -10)	45,3
With insulation, acoustic mesh ⁽²⁾ , and a sealing joint ⁽³⁾	50 (-5; -11)	46,2
ST-400	31 (-2; -1)	28,8
ST-415	-	-
Laminated safety glass VSG 55.1	33 (-1; 0)	32,2
Laminated safety glass VSG 66.1	35 (-1; -1)	34,2
Laminated safety glass VSG 66.1 Silence	36 (-1; -2)	35,2

Notes:

⁽¹⁾ Insulation boards made of 50 mm mineral wool with a density of 70 kg/m³.

⁽²⁾ 4 mm acoustic mesh placed between solid panels on the transmitter side of the acoustic chamber.

⁽³⁾ PVC sealing joint on the vertical joints between solid panels of different modular units.

4 Assessment and verification of constancy of performance (hereinafter AVCP) system applied, with reference to its legal base

According to the decision 1998/213/EC of the European Commission³, the systems of AVCP (see EC delegated regulation (EU) No 568/2014 amending Annex V to Regulation (EU) 305/2011) given in the following table applies.

Table 4.1: Applicable AVPC system.

Product	Intended use(s)	Level or class	System
Serie Trebe internal partition kit	For uses subject to reaction to fire	Conditions defined in the Decision 1998/0213/EC	3

5 Technical details necessary for the implementation of the AVCP system, as provided for in the applicable EAD

All the necessary technical details for the implementation of the AVCP system are laid down in the *Control Plan* deposited with the ITeC⁴, with which the factory production control shall be in accordance.

Products not manufactured by the kit manufacturer shall also be controlled according to the Control Plan.

Where materials/components are not manufactured and tested by the supplier in accordance with agreed methods, then they shall be subject to suitable checks/tests by the kit manufacturer before acceptance.

Any change in the manufacturing procedure which may affect the properties of the product shall be notified and the necessary type-testing revised according to the *Control Plan*.

Issued in Barcelona on 28 October 2022

by the Catalonia Institute of Construction Technology.



Ferran Bermejo Nualart
 Technical Director, ITeC

³ Official Journal of the European Union (OJEU) L 80/41 of 18/03/1998.

⁴ The *Control Plan* is a confidential part of the ETA and is only handed over to the notified certification body involved in the assessment and verification of constancy of performance.

Annex 1: Standard modular units

A1.1 ST-100

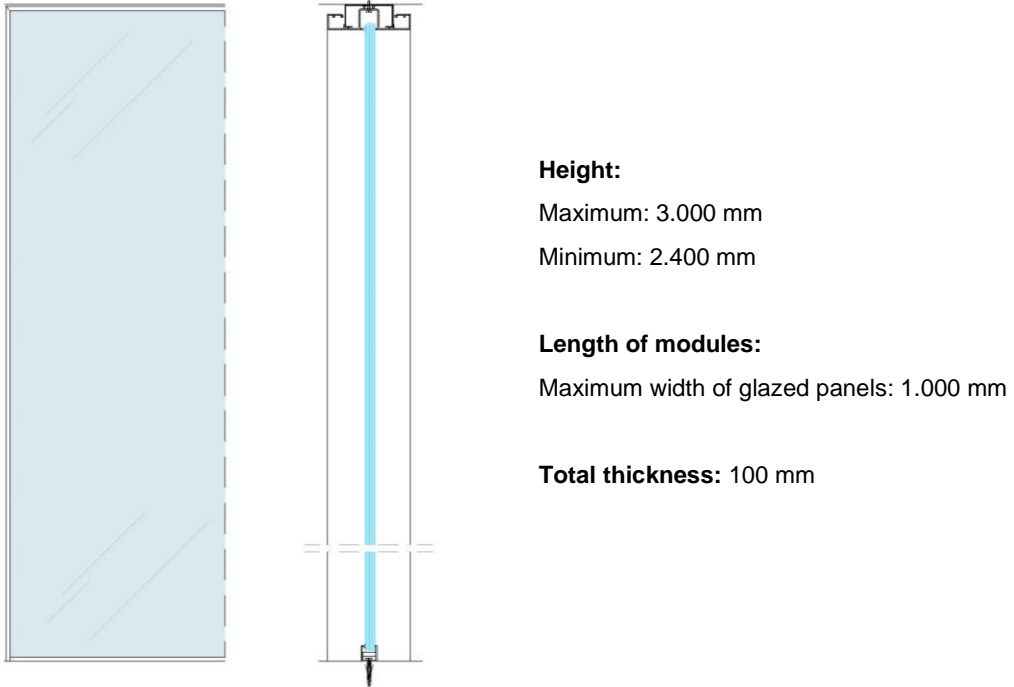

Figure A1.1: ST-100.

A1.2 ST-200

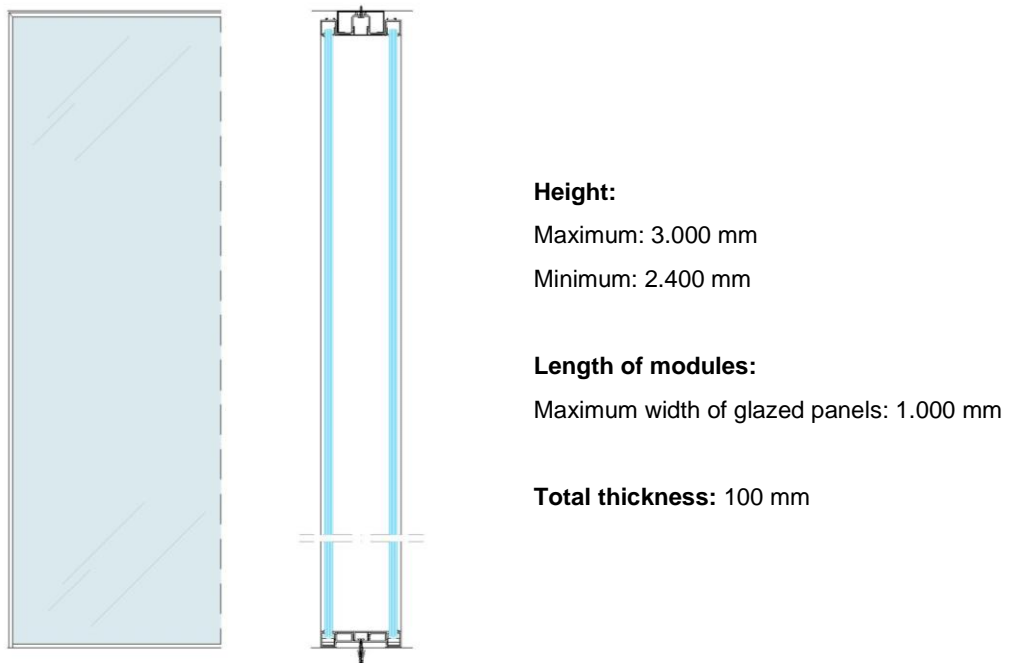
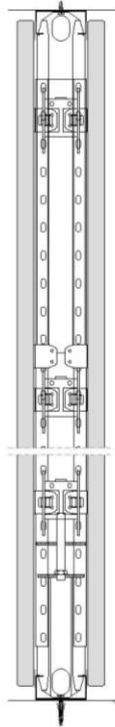

Figure A1.2: ST-200.

A1.3 ST-300



Height:

Maximum: 3.000 mm

Minimum: 2.400 mm

Length of modules:

Maximum: 1.000 mm

Minimum: 500 mm

(distance between vertical metal profiles must be multiple of 50 mm)

Total thickness: 100 mm

Figure A1.3: ST-300.

A1.4 ST-305

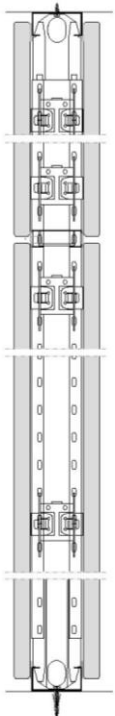

Total height:

Maximum: 3.000 mm

Minimum: 2.400 mm

Height of bottom panel: 2.055 mm

Height of top panel: from 345 mm to 945 mm

Length of modules:

Maximum: 1.000 mm

Minimum: 500 mm

(distance between vertical metal profiles must be multiple of 50 mm)

Total thickness: 100 mm

Figure A1.4: ST-305.

A1.5 ST-310

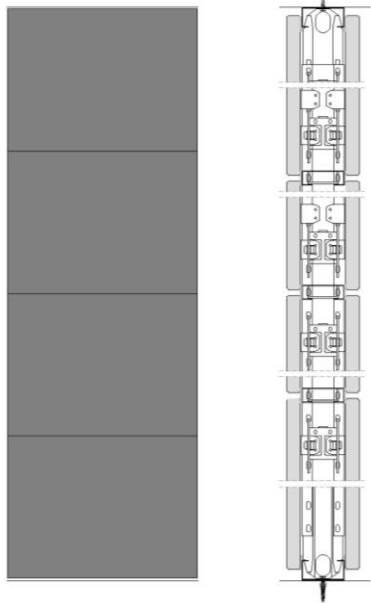

Total height:

Maximum: 3.000 mm

Minimum: 2.400 mm

Height of each panel: according to Table A1.

Length of modules:

Maximum: 3.000 mm

Minimum: 500 mm

(distance between vertical metal profiles must be multiple of 50 mm)

Total thickness: 100 mm

Figure A1.5: ST-310.

Table A1: Height of each of the four panels of ST-310.

Position of the panel	Possible height of each panel [mm]					
	637 to 537	641 to 542	677 to 578	681 to 582	749 to 650	753 to 654
Top panel	637 to 537	641 to 542	677 to 578	681 to 582	749 to 650	753 to 654
Mid-top panel	608	640	672	704	704	736
Mid-bottom panel	608	640	672	704	704	736
Bottom panel	647	679	679	711	743	775

A1.6 ST-340

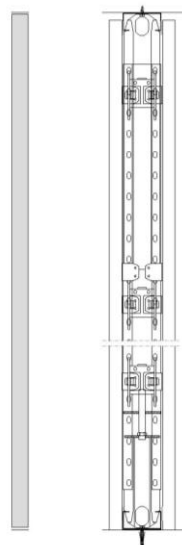

Total height:

Maximum: 3.000 mm

Minimum: 2.400 mm

Length of modules:

Maximum: 200 mm

Minimum: 100 mm

Total thickness: 100 mm

See possible configurations in Annex 3.

Figure A1.6: ST-340.

A1.7 ST-400

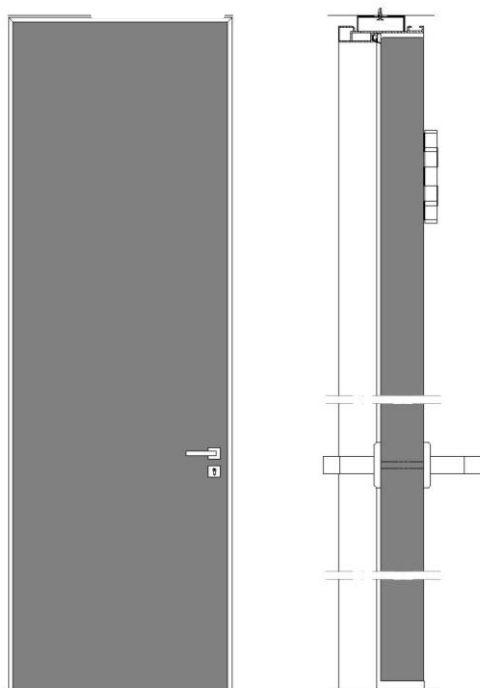

Total height:

Maximum: 3.000 mm

Minimum: 2.400 mm

Length of modules:

Single leaf door: 1.000 mm

Double leaf door: 2.000 mm

Total thickness: 100 mm

Figure A1.7: ST-400.

A1.8 ST-415

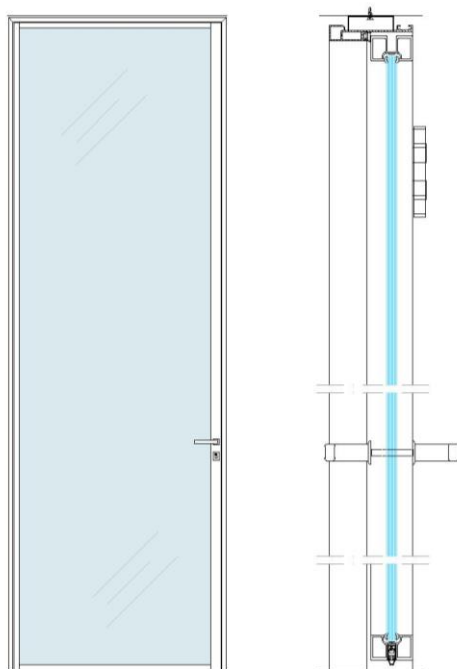

Total height:

Maximum: 3.000 mm

Minimum: 2.400 mm

Length of modules:

Single leaf door: 1.000 mm

Double leaf door: 2.000 mm











Total thickness: 100 mm

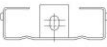



Figure A1.8: ST-415.

Annex 2: List of components

A2.1 Profiles and components of the structure







Chemical composition of steel according to EN 10240.







Code	Profile / Specification	Section	Dimensions (mm)
01	Floor to ceiling support guide SG L=3050. Galvanized and pre-painted steel; 0,8 mm thick		58 x 27 x 0,8
02	Vertical support SV. Galvanized steel; 1 mm thick.		58 x 20 x 1
03	Upper telescopic L=390. Galvanized steel; 1 mm thick.		55,5 x 17,5 x 1
04	Clip Scaled and zinc coated steel; 2 mm thick.		74,5 x 42 x 11
05	Horizontal Support L=980. Galvanized steel; 1 mm thick.		58 x 20 x 1
06	Horizontal Support clip. Scaled and zinc coated steel; 2 mm thick.		42 x 25 x 2
07	Floor plate for vertical support. Zinc coated steel plate; 15x3 mm.		53 x 45 x 3
08	Glass clip 10 mm. Tempered and zinc coated steel 1 mm.		27 x 26 x 10
09	Clip 20 mm. Tempered and zinc coated steel 1 mm.		27 x 26 x 20
10	Positioner clip. Tempered and zinc coated steel 1 mm.		27 x 26 x 20
11	Door frame guide L=1250 mm. Galvanized and pre-painted steel; 0,8 mm		55,5 x 15,5 x 1

Code	Profile / Specification	Section	Dimensions (mm)
12	Hinge reinforcement for SV. Galvanized steel; 1 mm thick.		100 x 19 x 2
13	Hinge reinforcement for upper telescopic. Galvanized steel; 1 mm thick.		60 x 50 x 2
14	Door frame mitre bracket. Scaled and zinc coated steel; 2 mm thick.		30 x 50 x 2
15	Strike for single leaf door. Inox steel; 1 mm thick.		30 x 50 x 2
16	Hinge plate to level door leaves in height. Zinc coated steel plate; 14x3 mm.		95 x 14 x 3

A2.2 Aluminium profiles

Chemical composition of the aluminium according to EN AW -6060 (Al, Mg, Si), according to EN 573-3. Dimensional tolerances and shape according to EN 755-2.

Code	Profile / Specification	Section	Dimensions (mm)
19	Floor guide profile. ST-100 system		19,5 x 19 x 1,3
20	Upper profile for single glass. ST-100 system		100 x 27,5 x 1,5
21	Vertical profile for single glass. ST-100 system		100 x 19 x 1,5
22	Upper profile for double glass. ST-200 system		100 x 27,5 x 1,5
23	Vertical profile for double glass. ST-200 system		100 x 19 x 1,5
24	Cover profile for double glass 5+5. ST-200 system		100 x 19 x 1,5

Code	Profile / Specification	Section	Dimensions (mm)
25	Cover profile for double glass 6+6. ST-200 system		100 x 19 x 1,5
27	Door frame profile. Universal frame for SERIE TREBE		100 x 19 x 2
28	Lock side profile for framed single glass door. ST-415 door		60 x 50 x 2
29	Hinge side profile for framed single glass door. ST-415 door		30 x 50 x 2
30	Upper/Lower side profile for framed single glass door. ST-415 door		30 x 50 x 2
36	Technical panel cover profile. ST-340 system		19,5 x 19 x 1,3

A2.3 Profiles standard finishes



Silver Anodized

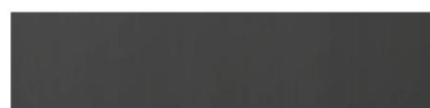

Black Powder Coated



White Powder Coated

A2.4 Panels and solid doors

Low emission of formaldehydes E1 P2 CE Eurospan chipboard is used. Panels are covered by melamine coating.

Code	Panel Type	Thickness (mm)	Material / Specification
89	Solid wall panels	19	EURODEKOR: 19 mm Eurospan Eurospan E1 P2 CE. D- s1 - d0 Quality
91	Solid door leaves, made of 8 mm double panel, and polyethylene board internally.	50	EURODEKOR: 8 mm Eurospan Eurospan E1 P2 CE. D- s1 - d0 Quality
90	Extruded polystyrene rigid foam	34	Euroclase E, self extinguishing and without burning droplets; this avoids flame propagation in the event of fire.

A2.5 Standard melamine finish

Plain melamine:

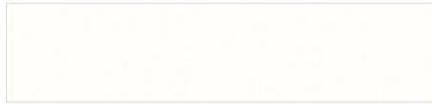

100 White W980 ST2



106 Pearl grey U763 ST9



111 Cashmere U702 ST9



116 Shadow U963 ST9

Imitation melamine:



200 Aluminium F509 ST2



212 Polar Pine H3433 ST22



221 Natural Oak H3157 ST12



240 Shorewood H3090 ST22



245 Blackwood U 999 ST19

A2.6 Solid door edge

Code	Panel Type	Thickness (mm)	Material / Specification
92	ABS Edge	50 x 2	ABS semi-rigid solid ABS
	MA - 6585 Adhesive		Thermal fuse adhesive base en EVA copolymers. (Ethylene vinyl acetate)

A2.7 Adhesives

Code	Profile / Specification	Section	Dimensions (mm)
65	Double side adhesive tape for 6+6 glass.	1.5 x 9	Acrylic adhesive
66	Double side adhesive tape for 5+5 glass.	1.5 x 6	Acrylic adhesive
67	Polyethylene tape	20 x 2	Adhesive tape to be fixed onto the metallic structure and isolate from the rest of the components

A2.8 Components and accessories



Code	Type	Material / Specification	Dimensions (mm)
44	Hinge for solid door	Stainless steel 3 mm. 200.000 opening cycles according to UNE EN 1935:2002. with 120 kg.	101,5 x 89 x 3
46	Door stop	Brushed stainless steel. Black rubber ring. Fixing to the floor by nylon anchor.	Ø 20 x 26
73	Cylinder 40-35	Brass / Nickel matt finish. Long cam. Tested according to UNE-EN 1303:2006	75 x 26 x 11
74	Cylinder 40-85	Brass / Nickel matt finish. Long cam. Tested according to UNE-EN 1303:2006	125 x 26 x 11
76	DALLAS handles	Female part handle for internal door. 8 mm spindle. Inox matt F69 finish.	130 x 55 x 20
77	Pair of squared rosettes	Stainless steel 304/ Polyamide A6. Concealed fixing.	52 x 52 x 10
79	Pair of escutcheons	Stainless steel 304/ Polyamide A6. Concealed fixing.	52 x 52 x 10
82	Spindle 8	Zinc plated steel	8 x 135 8 x 185
84	Pair of mini-rosettes	Stainless steel 304	30 x 30 x 2
85	Pair of mini-escutcheons	Stainless steel 304	30 x 50 x 2
87	Lock back set 30	Lock for European cylinder. Distance between centres 92 mm. Strike and key.	236 x 190 x 16
69	Lock back set 55	Lock for European cylinder. Distance between centres 72 mm. Strike and key.	235 x 165 x 16

A2.9 Assembly components

Code	Type	Material / Specification	Dimensions (mm)
45	Duopower bracket	Nylon.	_____
47	Tubular rivet	Heart and pin A2 .	_____
48	Screw 4x35	Zinc plated steel DIN 7505. Particle board screw anchor or use with nylon dowel.	_____

Code	Type	Material / Specification	Dimensions (mm)
49	ScREW 20x4	Zinc plated steel DIN 7505. Particle board screw anchor.	_____
51	Selfdrilling screw 3,9x32	Zinc plated steel DIN 7004 P. Drilling point.	_____
52	Selfdrilling screw 3,9x16	Zinc plated steel DIN 7004 P. Drilling point	_____
53	Selfdrilling screw 4,8 x 19	Zinc plated steel DIN 7004 P. Drilling point	_____
55	Trilobular screw M5x12	Zinc plated steel DIM 7500 M. Tornillo autoroscante.	_____
60	Lock trim	PPL - Polypropylene.	243 x 88 x 0,8
61	Calibrated chock 2,3,4,5 mm	PEAD 50% - PEBD 50%.	30 x 50 x 2,3,4,5
75	Mitre union bracket	Cast aluminium.	31,7 x 31,7 x 10,7
88	Set screw M5x4	Blued steel. Point screw.	_____

A2.10 Tapes and gaskets

Code	Section	Profile / Specification	Dimensions (mm)
56	Transparent glass gasket 5,0. Flexible rubber to fix glass panels. TPE material.		8,5 x 5
58	Swing door gasket. Flexible rubber to fix glass panels. TPE material.		100 x 27,5 x 1,5

A2.11 Glasses

Code	Configuration	Use
94	Laminated safety glass VSG 55.1	Demountable wall's closures. Framed glass door leaves.
95	Laminated safety glass VSG 66.1	Demountable wall's closures. Framed glass door leaves.
96	Laminated safety glass VSG 66.1 Silence	Demountable wall's closures. Framed glass door leaves.

Annex 3: Solutions and construction details

ST-100 / ST-300 / ST-340 / ST-415

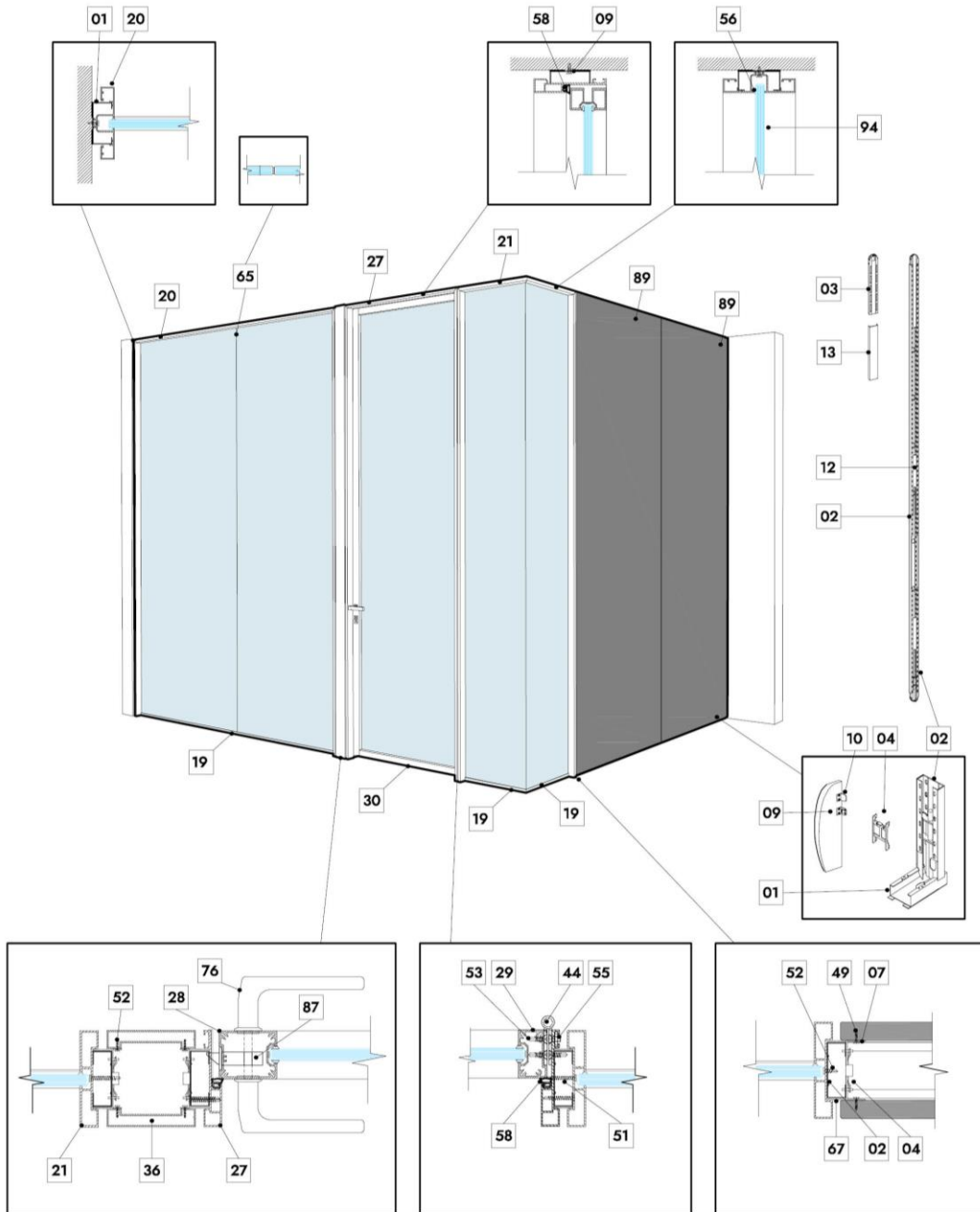

ST-200 / ST-300 / ST-340 / ST-400

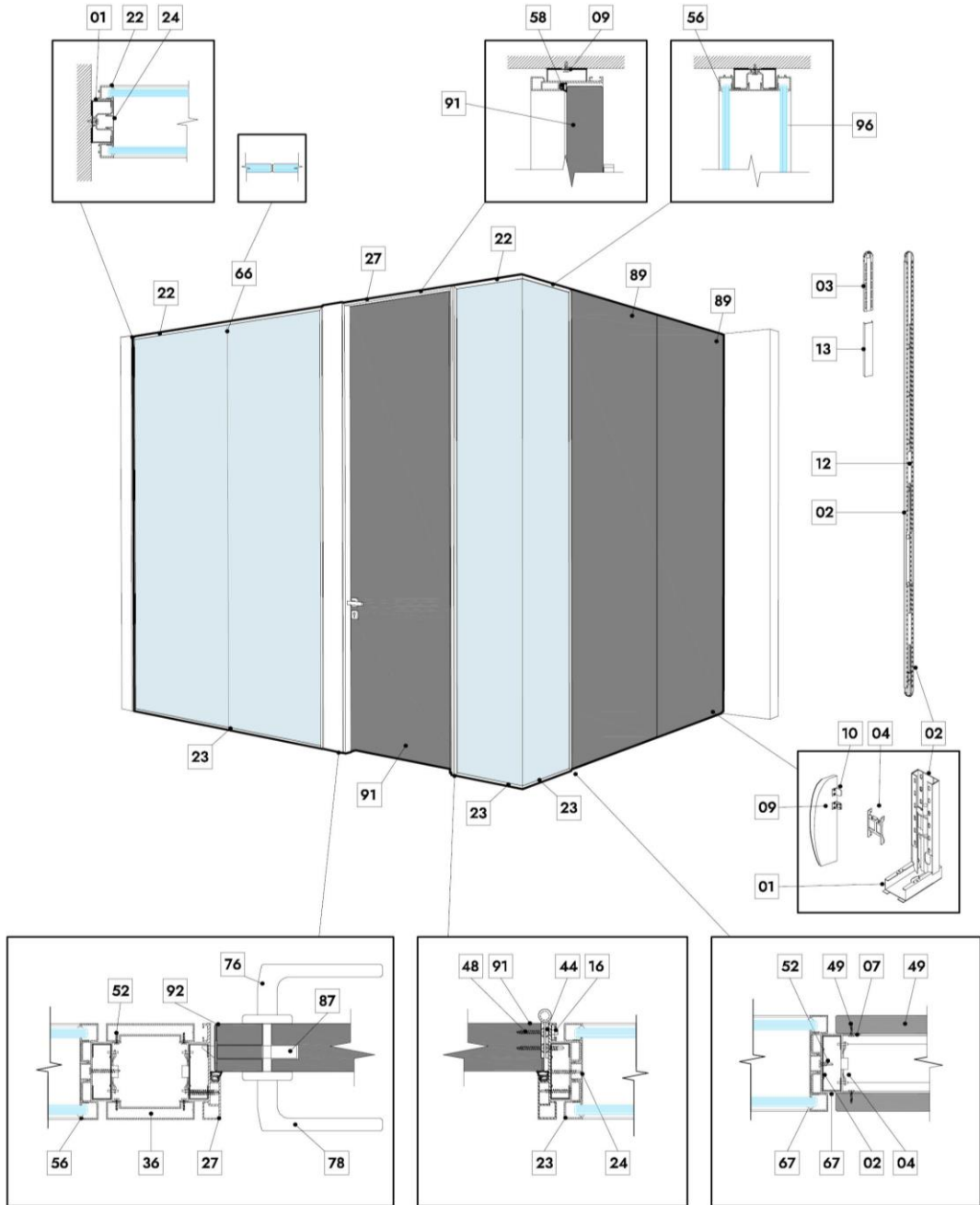

ST-100 / ST-305 / ST-340 / ST-415

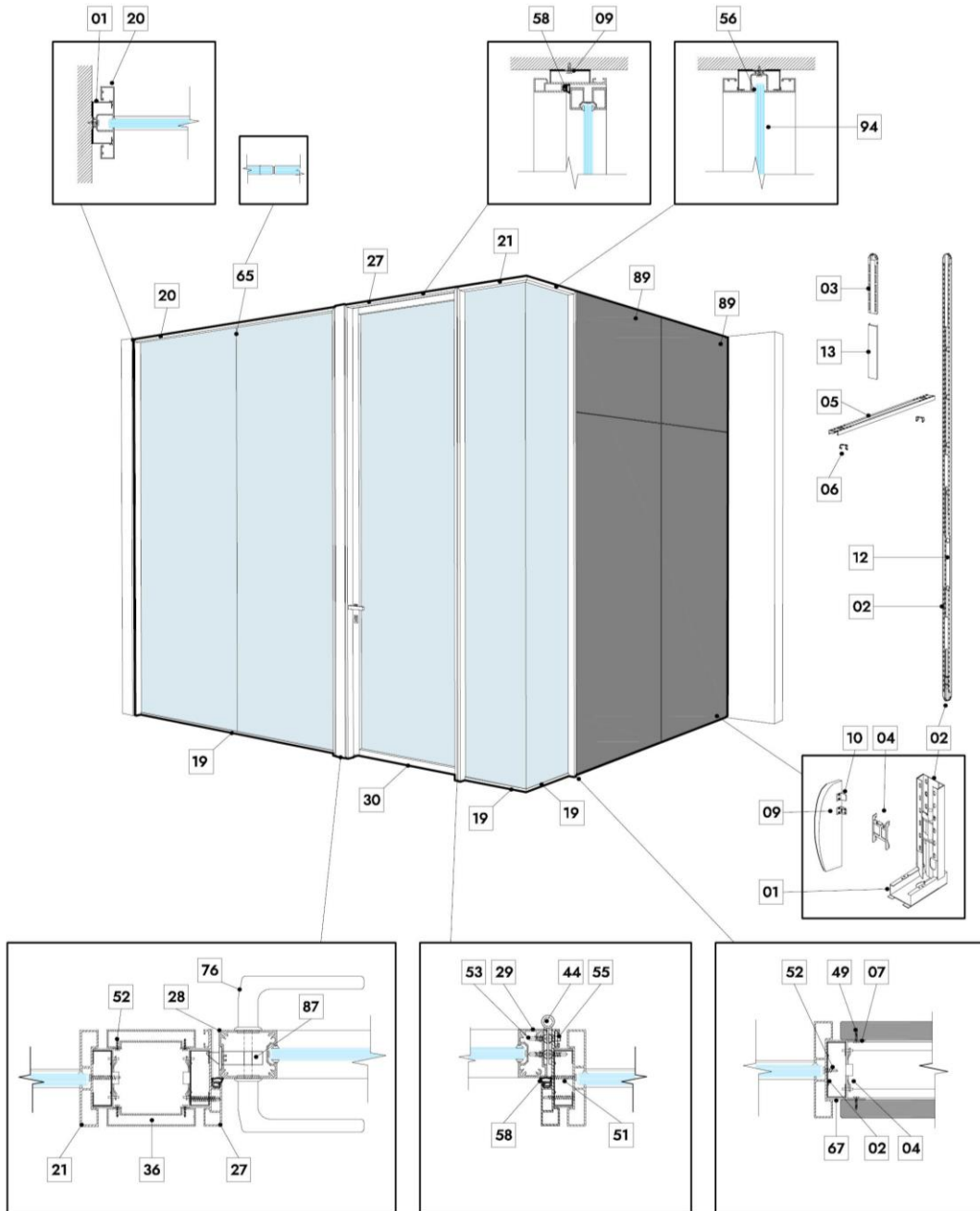

ST-200 / ST-305 / ST-340 / ST-400

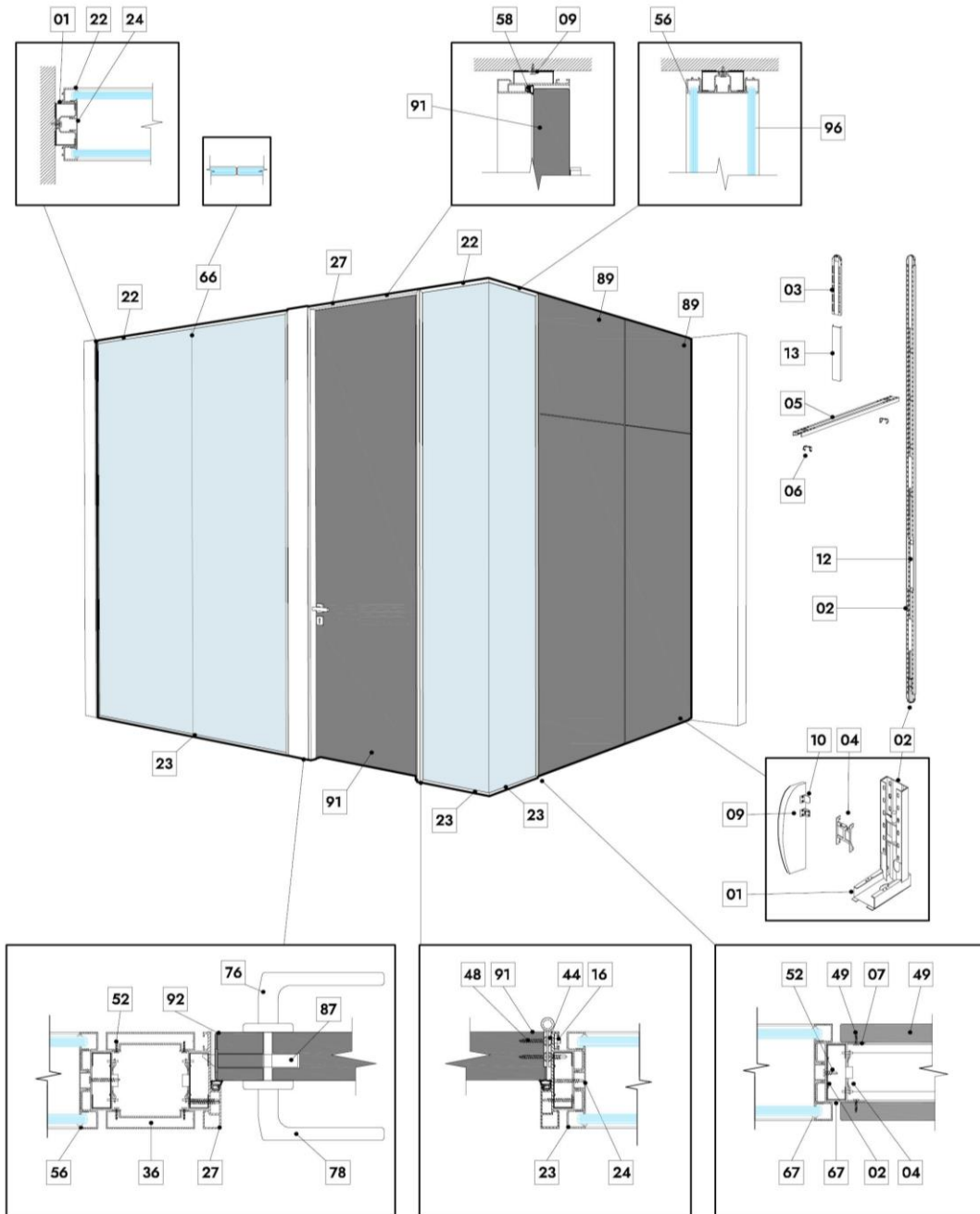

ST-100 / ST-310 / ST-340 / ST-415

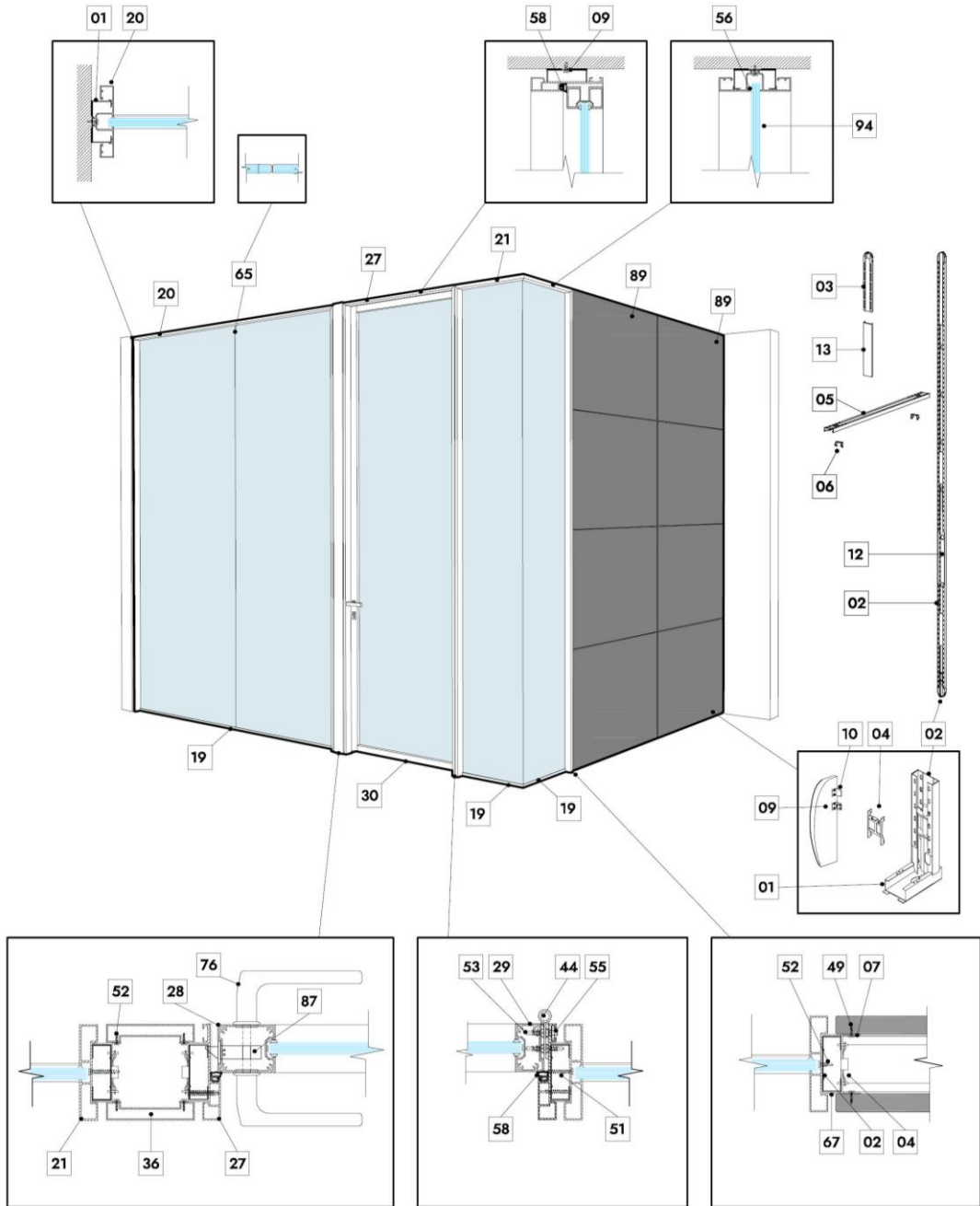

ST-200 / ST-310 / ST-340 / ST-400

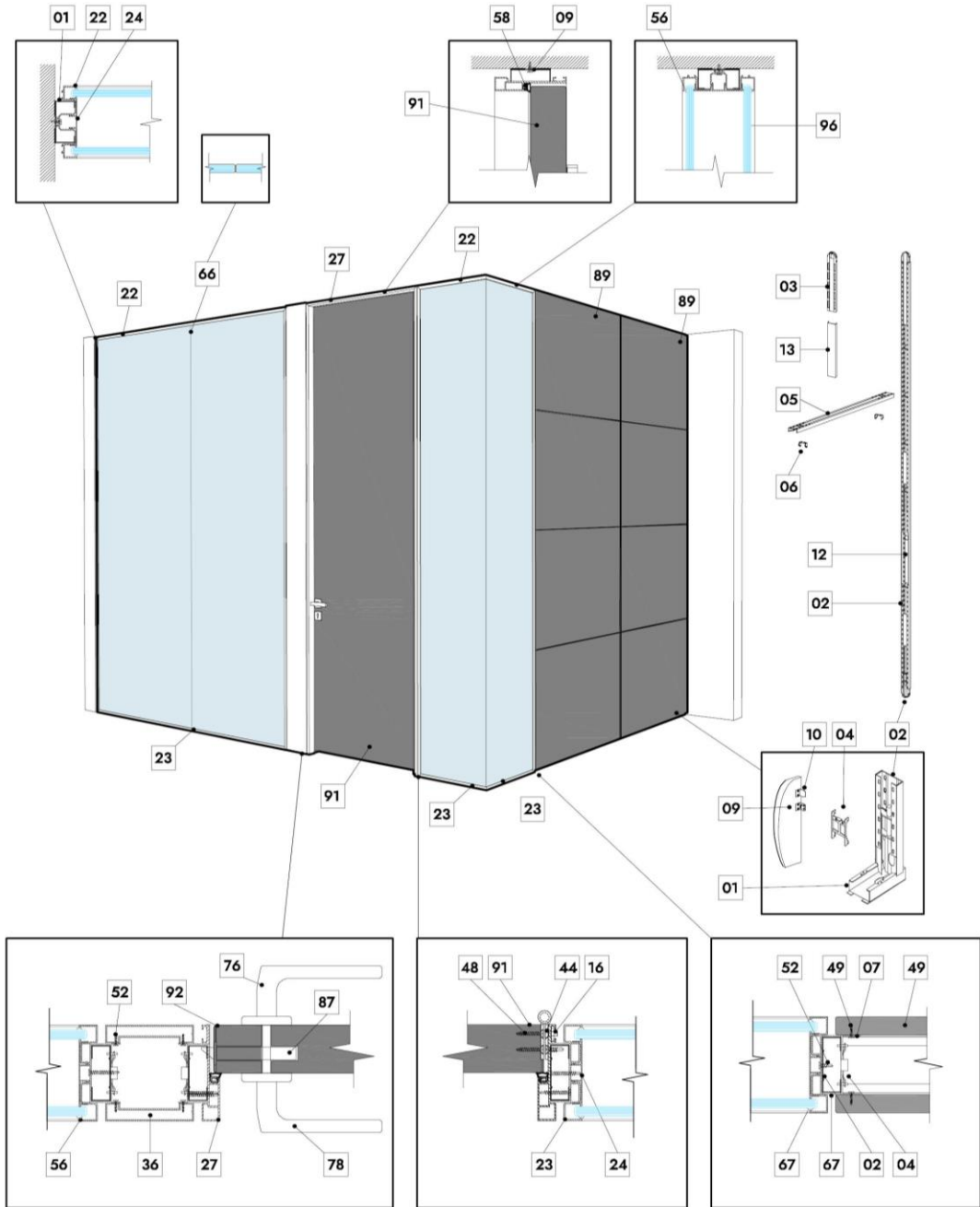

ST-340

