

European Technical Assessment

ETA 21/1049
of 06.05.2022



General part

Technical Assessment Body issuing the ETA: ITeC	
ITeC has been designated according to Article 29 of Regulation (EU) No 305/2011 and is member of EOTA (European Organisation for Technical Assessment)	
Trade name of the construction product	Kit for Glasroc® X cladding system
Product family to which the construction product belongs	Kits for external wall claddings of mineral boards with renderings applied in-situ
Manufacturer	SAINT-GOBAIN PLACO Tour Saint-Gobain 12, Place de l'Iris 92400, Courbevoie (France)
Manufacturing plant(s)	According to Annex N kept by ITeC.
This European Technical Assessment contains	25 pages including 7 annexes which form an integral part of this assessment.
This European Technical Assessment is issued in accordance with Regulation (EU) 305/2011, on the basis of	EAD 090119-00-0404 <i>Kits for external wall claddings of mineral boards with renderings applied in-situ. July 2018.</i>

General comments

Translations of this European Technical Assessment in other languages shall fully correspond to the original issued document and should be identified as such.

Communication of this European Technical Assessment, including transmission by electronic means, shall be in full. However, partial reproduction may be made, with the written consent of issuing Technical Assessment Body. Any partial reproduction has to be identified as such.

Specific parts of the European Technical Assessment

1 Technical description of the product

This ETA refers to the kit for Glasroc® X cladding systems in ventilated and non-ventilated façades.

This kit consists of eight rendering systems (different combinations of base-coats and finishing coats), the Glasroc® X board (gypsum board with fibrous reinforcement) and the board-fixings (for aluminium subframe).

Kit components are given in table 1.1 related with Glasroc® X cladding systems components.

Detailed information and data of all the components are given in the annexes of this ETA.

Table 1.1: Cladding system components.

Assembled system layer	Glasroc® X cladding systems	Technical description
Rendering systems	FC: Finishing coat	Annex 2
	P: Primer	
	BC: Base-coat	
	M: Reinforcement mesh	
External layer	EB: Glasroc® X board	Annex 3
	Fix: Glasroc® X board fixings	Annex 5
	WPL: Flexible sheet for waterproofing (*)	
Subframe (*)	ASF: Aluminium alloy subframe with vertical profiles, brackets and subframe fixings (*)	Annex 4
Others	Fixings between the subframe and the supporting structure (*)	Annex 4
	Thermal insulation (*)	Annex 5
(*) These components are not part of the kit but of the assembled system. They are not supplied by the kit manufacturer; however, they are available on the market, and they have to meet the specifications indicated in this ETA (see Annex 4 and Annex 5).		

The fixings between the subframe brackets and the supporting structure are always needed for the execution of the assembled systems, and they should be chosen according to the supporting structure material and the resistance required due to wind load and dead load.

2 Specification of the intended use(s) in accordance with the applicable European Assessment Document (hereinafter EAD)

Kit for Glasroc® X cladding systems based on aluminium alloy subframe is to be used as:

- Use 1: Ventiladed cladding systems (rain-screens) for external walls.
- Use 2: Non-ventilated cladding systems for external walls.

This ETA covers the kits for family 1 (for aluminium alloy subframe) according to table 1.1 of EAD 090119-00-0404 as shown in tables of Annex 1.

The provisions made in this European Technical Assessment are based on an assumed working life of at least 25 years for the kits. The indications given on the working life cannot be interpreted as a guarantee given by the producer but are to be regarded only as a means for choosing the right products in relation to the expected economically reasonable working life of the works.

Glasroc® X cladding systems are made of non-load bearing construction components. They do not contribute directly to the stability of the wall on which they are installed, but they may contribute to its durability by providing enhanced protection from the effect of weathering.

Construction details are given in Annex 6.

3 Performance of the product and reference to the methods used for its assessment

The assessment of kit for Glasroc® X cladding systems for the intended use was performed following EAD 090119-00-0404 *Kits for external wall claddings of mineral boards with renderings applied in-situ*.

Table 3.1: Summary of the performance (see also detailed performances in relevant annexes).

Basic Works Requirement	EAD clause	Essential characteristic	Performance	
			Use 1	Use 2
BWR 2 Safety in case of fire	2.2.1	Reaction to fire	See table A1.2 in Annex 1	
	2.2.2	Façade fire performance	Not assessed	
	2.2.3	Propensity to undergo continuous smouldering	Not assessed	
BWR 3 Hygiene, health and the environment	2.2.4	Watertightness (protection against driving rain)	See table A1.2 in Annex 1	
	2.2.5	Water absorption	See table A1.2 in Annex 1	
	2.2.6	Water vapour permeability	Not relevant	See table A1.2 in Annex 1
	2.2.7	Drainability	See table A1.2 in Annex 1	
	2.2.8	Content, emission and/or release of dangerous substances	Not assessed	
BWR 4 Safety and accessibility in use	2.2.9	Wind load resistance	See clause 3.1	
	2.2.10	Impact resistance	See table A1.2 in Annex 1	
	2.2.11	Resistance to horizontal point loads	Not assessed	
	2.2.12.1	Bond strength	See table A1.2 in Annex 1	
	2.2.12.2	Bending strength of the board	See table A1.2 in Annex 1	
	2.2.12.3	Embedding/Shear strength	See table A1.2 in Annex 1	
	2.2.12.4	Fixing pull-through / pull-out strength	See table A1.2 in Annex 1	
	2.2.12.5	Resistance of profiles	Not assessed	
	2.2.12.6	Tension/pull-out resistance	Not assessed	
2.2.12.7	Shear load resistance	Not assessed		
2.2.12.8	Bracket resistance (horizontal and vertical load)	Not assessed		
BWR 5 Protection against noise	2.2.13	Airborne sound insulation	See clause 3.2	
BWR 6 Energy economy and heat retention	2.2.14	Thermal resistance	Not relevant	Not assessed
Aspects of durability	2.2.15.1	Accelerated ageing behaviour	See table A1.2 in Annex 1	
	2.2.15.2	Cracking strength due to board deformation	Not assessed	
	2.2.15.3	Dimensional stability by humidity	See table A1.2 in Annex 1	
		Dimensional stability by temperature	See table A1.2 in Annex 1	
	2.2.15.4	Moisture content	Not assessed	
	2.2.15.5	Corrosion	See table A1.2 in Annex 1	
2.2.15.6	UV radiation resistance	Not assessed		

Complementary information:

Requirements with respect to the mechanical resistance and stability of non-load bearing parts of the works are not included in the Basic Works Requirement *Mechanical resistance and stability* (BWR 1) but are treated under the Basic Works Requirement *Safety and accessibility in use* (BWR 4).

The fire resistance requirement is applicable to the wall (made of masonry, concrete, timber or metal frame) and not to the kit itself.

3.1 Wind load resistance

The wind load resistance of the kit has been assessed according to clause 2.2.9 of EAD 090119-00-0404.

Table A1.2 in Annex 1 gives the wind load resistance obtained in the test carried out for Glasroc® X cladding systems based on aluminium alloy subframe.

In addition, table 3.1 gives the wind load resistance for other different span of subframe considering the components specifications given in Annex 4.

Table 3.1: Wind load resistance for kits with aluminium subframe.

Span between (mm)		Characteristic value Q (kN/m ²) (*)	Failure condition
Vertical profiles	Brackets		
400	500	≤ 2,5	Connection board-fixing limit (300 N design load)
	750		
	1000		
	1250	≤ 1,9	Elastic limit of the vertical profile material (170 MPa)
	1500	≤ 1,3	
600	500	≤ 1,6	Connection board-fixing limit (300 N design load)
	750		
	1000		
	1250	≤ 1,3	Elastic limit of the vertical profile material (170 MPa)
	1500	≤ 0,9	

(*) Calculated values using continuous beam uniformly distributed load with three supports formulas.

In other configurations of the assembled system (other subframe components), the wind load resistance may be calculated according to:

- Horizontal load resistance characteristic value of brackets, e.g., for 1 mm residual distortion.
- Maximum tension of the vertical profiles, elastic limit of profile material.
- Maximum deflection of the vertical profiles, L/200.

This calculated wind load value should not be greater than the maximum resistance given in table A1.2 of Annex 1.

3.2 Airborne sound insulation

The airborne sound insulation is to be assessed by means of the following characteristics:

- Improvement of the airborne sound insulation of the assembled system according to clause 2.2.13.1 of EAD 090119-00-0404.

Table 3.2 gives the airborne sound insulation Glasroc® X cladding systems based on aluminium alloy subframe.

- Airflow resistivity of the assembled system thermal insulation according to clause 2.2.13.2 of EAD 090119-00-0404.

Airflow resistivity has not been assessed.

Table 3.2: Improvement of airborne sound insulation test results.

Test	Specimen (*)	Thickness (mm)	Mass per unit area (kg/m ²)	Results
Airborne sound insulation	Basic weight wall	170	310	R _w (C; C _{tr}) = 54 (-1; -5) dB
	Basic weigh wall + Assembled kit – aluminium subframe	263	322	R _w (C; C _{tr}) = 64 (-2; -6) dB
Improvement of airborne sound insulation	Assembled kit – aluminium subframe on basic weight wall	Δe = 93	Δm = 12	ΔR _w = 10 dB Δ(R _w +C) = 9,9 dB; Δ(R _w +C _{tr}) = 9; 9 dB
R _w = weighted sound reduction index. ΔR _w = improvement of weighted sound reduction index.				
(*) Specimen configuration: <ul style="list-style-type: none"> - Basic weigh wall according to Annex B of EN ISO 10140-5. - Boards dimensions 2400x1200x12,5 mm with its joint treatment and reinforced base-coat (4 mm total thickness). Total superficial mass (boards and rendering) is 16,1 kg/m². - Aluminium alloy subframe, maximum span between vertical profiles and brackets. - Thermal insulation panels made of mineral wool 50 mm thickness and 20 kg/m³ density, attached to the wall by means of 4 mechanical fixings with plate. - Air space 30 mm. 				

4 Assessment and verification of constancy of performance (hereinafter AVCP) system applied, with reference to its legal base

According to the decision 2003/640/EC, as amended of the European Commission¹, the systems of AVCP (see EC delegated regulation (EU) No 568/2014 amending Annex V to Regulation (EU) 305/2011) given in the following table apply.

Table 4.1: Applicable AVPC system.

Product	Intended use	Level or class	System
Kits for external wall claddings of mineral boards with renderings applied in-situ	without flexible sheet for waterproofing	not subject to fire regulations	2+
		subject to fire regulations	3
	with flexible sheet for waterproofing	not subject to fire regulations	2+
		subject to fire regulations	3 or 4

¹ 2003/640/EC – Commission Decision of date 4 September 2003, published in the Official Journal of the European Union (OJEU) L226/21 of 10/09/2003.

5 Technical details necessary for the implementation of the AVCP system, as foreseen in the applicable EAD

All the necessary technical details for the implementation of the AVCP system are laid down in the *Control Plan* deposited with the ITeC², with which the factory production control shall be in accordance.

Issued in Barcelona on 6 May 2022

by the Catalonia Institute of Construction Technology.



Ferran Bermejo Nualart
Technical Director, ITeC

² The *Control Plan* is a confidential part of the ETA and is only handed over to the notified certification body involved in the assessment and verification of constancy of performance.

ANNEX 1 - GLASROC® X CLADDING SYSTEMS

Table A1.1: Description of Glasroc® X cladding systems – Family 1.

	Family 1 – vertical profiles fixed by means of the webs					
	<p>Use: Non-ventilated and ventilated cladding systems</p> <p>Release scenario with respect to dangerous substances: S/W2: Product with indirect contact to soil, ground- and surface water.</p> <p>Subframe material: Aluminium alloy.</p>					
<ol style="list-style-type: none"> 1. Finishing coat. 2. Primer. 3. Base-coat and reinforcement mesh. 4. Board and joint treatment. 5. Flexible sheet for waterproofing (optional). 6. Subframe, thermal insulation (optional) and substrate. 	System main components:					
	<table border="1"> <tr> <td rowspan="2">Cladding element</td> <td>Rendering system</td> <td>See Annex 2</td> </tr> <tr> <td>Glasroc® X</td> <td>See Annex 3</td> </tr> </table>	Cladding element	Rendering system	See Annex 2	Glasroc® X	See Annex 3
Cladding element	Rendering system		See Annex 2			
	Glasroc® X	See Annex 3				
	Board-fixing	See Annex 4				
	Aluminium alloy subframe (*)	See Annex 5				
	Flexible sheet for waterproofing (*)	See Annex 4				
	Thermal insulation (*)					
	Fixings between the subframe and the substrate (*)	See Annex 4				

(*) These components are not part of the kit but of the assembled system. They are not supplied by the manufacturer; however, they are available on the market and they have to meet the specifications indicated in the respective Annexes.

Glasroc® X cladding systems	Annex A1 of European Technical Assessment ETA 21/1049
Family 1 - Aluminium alloy subframe	

Table A1.2: Performance for Glasroc® X cladding systems. Family 1 - Aluminium alloy subframe.

Nr	Essential characteristic	Kit for Glasroc® X cladding systems relevant configuration	Performance			
Basic Works Requirement 2: Safety in case of fire						
1	Reaction to fire (front side)	Glasroc® X (EB1) as external-board and rendering system (Var1 to Var8)	B-s1,d0			
	Reaction to fire (rear side)	Glasroc® X (EB1) without flexible sheet for waterproofing	A1			
		Glasroc® X (EB1) with flexible sheet for waterproofing (WPL1)	B-s1,d0			
		Glasroc® X (EB1) with flexible sheet for waterproofing (WPL2)	E			
2	Façade fire performance	Not assessed				
3	Propensity to undergo continuous smouldering	Not assessed				
Basic Works Requirement 3: Hygiene, health and the environment						
4	Watertightness (protection against driving rain)	Glasroc® X (EB1) as external-board, any rendering system (Var1 to Var8) with or without flexible sheet of waterproofing (WPL1 or WPL2)	1350 Pa without water penetration			
5	Water absorption by capillarity	Glasroc® X (EB1) as external-board and rendering system (Var1 to Var3)	without ageing	(3 min) kg/m ²	(1 h) kg/m ²	(24 h) kg/m ²
			after hygrothermal cycles	0,12	0,19	0,42
		Glasroc® X (EB1) as external-board and base coat (BC1)	without ageing	0,02	0,01	0,07
			after hygrothermal cycles	0,01	0,01	0,09
		Glasroc® X (EB1) as external-board and rendering system (Var4 to Var6)	without ageing	0,11	0,04	0,33
			after hygrothermal cycles	0,11	0,02	0,20
		Glasroc® X (EB1) as external-board and base-coat (BC2)	without ageing	0,10	0,12	0,59
			after hygrothermal cycles	0,13	0,13	0,53
		Glasroc® X (EB1) as external-board and rendering system (Var7 & Var8)	without ageing	0,02	0,04	0,26
			after hygrothermal cycles	0,02	0,02	0,10
		Glasroc® X (EB1) as external-board and base-coat (BC3)	without ageing	0,17	0,09	0,51
after hygrothermal cycles	0,28		0,48	0,61		
Water permeability (water column)			Not assessed			
Water absorption of the board		Glasroc® X (EB1)	< 100 g/m ² in 2 h (partial immersion) < 5% (total immersion)			
Watertightness of the breather membrane		Flexible sheet for waterproofing (WPL1 or WPL2)	Not assessed			
6	Water vapour permeability of the rendering system	Var1 to Var8 on Glasroc® X (EB1)	Not assessed			
	Water vapour permeability of the boards	Glasroc® X (EB1)	μ = 18,2			
	Water vapour permeability of the thermal insulation	Mineral Wool	Not assessed (thermal insulation is not a kit component)			
	Water vapour permeability of the breather membrane	Flexible sheet for waterproofing (WPL1 or WPL2)	Not assessed (flexible sheet for waterproofing is not a kit component)			
7	Drainability	Aluminium alloy subframe (ASF1)	No water accumulation or moisture damage or leakage. See Annex 6.			

Glasroc® X cladding systems	Annex A1
Family 1 - Aluminium alloy subframe	of European Technical Assessment ETA 21/1049

Nr	Essential characteristic	Kit for Glasroc® X cladding systems relevant configuration	Performance				
8	Content, emission and/or release of dangerous substances		Not assessed				
Basic Works Requirement 4: Safety and accessibility in use							
9	Wind load resistance	Glasroc® X (EB1), fixing boards 250 mm, aluminium alloy subframe (ASF1) with maximum span between vertical profiles 600 mm and span between brackets 750 mm.	2600 Pa; $\delta \leq L/200$ See also clause 3.1				
10	Impact resistance	Glasroc® X (EB1), rendering system (Var4 to Var6) and aluminium alloy subframe (ASF1) and with maximum span between profiles 600 mm	Resists (Category I): - Hard body 0,5 kg, 3 J - Hard body 1,0 kg, 10 J - Soft body 3,0 kg, 60 J - Soft body 50,0 kg, 400 J				
		Glasroc® X (EB1), rendering system (Var1 to Var3 and Var7 to Var8) and aluminium alloy subframe (ASF1) and with maximum span between profiles 600 mm	Hard body impacts: Not assessed Resists: - Soft body 3,0 kg, 60 J - Soft body 50,0 kg, 400 J				
11	Resistance to horizontal point loads	Glasroc® X (EB1) as external-board and rendering system (Var1 to Var8) and aluminium alloy subframe (ASF1)	Not assessed				
12	Bond strength	Glasroc® X (EB1) as external-board and rendering system (Var1 to Var3)	without ageing	Mean (R _m) MPa	Min. (R _{min}) MPa	Rupture (*)	
			after hygrothermal cycles	0,32	0,26	100% CP	
			after freeze-thaw cycles	0,27	0,21	100% CP	
		Glasroc® X (EB1) as external-board and base-coat (BC1)	without ageing	Not relevant			
			after hygrothermal cycles	0,24	0,21	100% CP	
		Glasroc® X (EB1) as external-board and rendering system (Var4 to Var6)	without ageing	0,18	0,15	100% CP	
			after hygrothermal cycles	0,23	0,19	100% CP	
			after freeze-thaw cycles	0,20	0,17	100% CP	
		Glasroc® X (EB1) as external-board and base-coat (BC2)	without ageing	Not relevant			
			after hygrothermal cycles	0,30	0,21	100% CP	
		Glasroc® X (EB1) as external-board and rendering system (Var7 to Var8)	without ageing	0,24	0,21	100% CP	
			after hygrothermal cycles	0,28	0,21	100% CP	
			after freeze-thaw cycles	0,23	0,17	100% CP	
		Glasroc® X (EB1) as external-board and base-coat (BC3)	without ageing	Not relevant			
after hygrothermal cycles	0,35		0,27	100% CP			
13	Bending strength of the board	Glasroc® X (EB1)	Longitudinal	8,4 MPa			
			Transversal	6,5 MPa			
14	Embedding/Shear strength	Glasroc® X (EB1) and screw (Fix1) Ø4,8 mm (a _{edge} ≥ 15 mm)	F _m = 805 N; F _c = 732 N				
15	Pull-through resistance	Glasroc® X (EB1) and screw (Fix1)	F _m = 744 N; F _c = 679 N				
	Pull-out resistance	Aluminium alloy subframe (ASF1) profile and screw (Fix1)	F _m = 1535 N; F _c = 1132 N				
16	Resistance of profiles	Aluminium alloy subframe (ASF1) profiles	Not assessed (subframe profile is not a kit component)				
17	Tension/Pull-out resistance of subframe fixings	Aluminium alloy subframe (ASF1) screws	Not assessed (subframe screw is not a kit component)				
18	Shear resistance of subframe fixings	Aluminium alloy subframe (ASF1) screws	Not assessed (subframe screw is not a kit component)				

Glasroc® X cladding systems	Annex A1
Family 1 - Aluminium alloy subframe	of European Technical Assessment ETA 21/1049

Nr	Essential characteristic	Kit for Glasroc® X cladding systems relevant configuration	Performance
19	Bracket resistance	Aluminium alloy subframe (ASF1) brackets	Not assessed (subframe bracket is not a kit component)
Basic Works Requirement 5: Protection against noise			
20	Improvement of the airborne sound insulation		See clause 3.2
	Airflow resistivity of the thermal insulation	Mineral wool	Not assessed (thermal insulation is not a kit component)
Basic Works Requirement 6: Energy economy and heat retention			
21	Thermal resistance	for use in non-ventilated façade	Not assessed
		for use in ventilated façade	Not assessed
Aspects of durability			
22	Accelerated ageing behaviour	Hygrothermal behaviour	No defects (see also points 5 & 12 in this table)
		Freeze thaw behaviour	Not relevant. Water absorption < 0,50 kg/m ²
		Combined hygrothermal and freeze thaw behaviour	Not assessed
23	Cracking strength due to board deformation		Not assessed
24	Dimensional stability by humidity. Expansion (30 % to 90 %)	Glasroc® X (EB1)	0,031 %
	Linear thermal expansion		0,008 mm/m·°C
	Linear thermal expansion	Aluminium alloy subframe (ASF1)	$\alpha = 23 \mu\text{m}/\text{m}\cdot\text{K}^{-1}$ for $T \leq 100 \text{ }^\circ\text{C}$
25	Moisture content	Glasroc® X (EB1)	Not assessed
26	Corrosion	Aluminium alloy subframe (ASF1) screw	See table A3.3
27	UV radiation resistance	Flexible sheet for waterproofing (WPL-1 and WPL-2)	Not assessed (flexible sheet for waterproofing is not a kit component)
(*) CP = Cohesive rupture in the Glasroc® X Board.			

Glasroc® X cladding systems	Annex A1
Family 1 - Aluminium alloy subframe	of European Technical Assessment ETA 21/1049

ANNEX 2 - RENDERING SYSTEMS COMPONENTS

Characteristic		Types							
		Var1	Var2	Var3	Var4	Var5	Var6	Var7	Var8
Generic components	Finishing coat (FC)	FC1	FC2	FC3	FC1	FC2	FC3	FC4	FC5
	Primer (P)	P1						P3	P2
	Base-coat (BC)	BC1			BC2			BC3	
	Reinforcement mesh (M)	M1							
Range of application thickness (mm)		5,0 – 8,2	5,0 – 8,2	3,5 – 6,2	5,0 – 8,2	5,0 – 8,2	3,5 – 6,2	4,5 – 6	4,5 – 6
Mass per square meter (kg/m ²)		7,5 – 11,6	6,8 – 10,5	4,7 – 7,8	7,5 – 11,6	6,8 – 10,5	4,7 – 7,8	6,8 – 9,7	6,8 – 9,7
PCS _s -value (i)	(MJ/kg)	≤ 1,73	≤ 1,84	≤ 1,84	≤ 2,29	≤ 2,29	≤ 2,62	≤ 2,62	≤ 2,62
	(MJ/m ²)	≤ 44,6	≤ 42,8	≤ 42,8	≤ 53,5	≤ 50,9	≤ 51,2	≤ 51,2	≤ 51,2
Reaction to fire		B-s1,d0							
Water absorption by capillarity (kg/m ²) (i)	after 3 min. (ii)	0,11	0,11 (iv)	0,11	0,04	0,12 (iv)	0,12	0,013	0,013
	after 1 h. (iii)	0,04	0,04 (iv)	0,04	0,03	0,19 (iv)	0,19	0,026	0,033
	after 24 h. (iii)	0,29	0,33 (iv)	0,33	0,12	0,42 (iv)	0,42	0,201	0,253
Bond strength (MPa) (i)	Mean	0,33	0,32 (iv)	0,32	0,23	0,23 (iv)	0,30	0,28	0,28
	Minimum	0,29	0,29 (iv)	0,29	0,19	0,19 (iv)	0,23	0,25	0,21
	Cohesive rupture	100%	100% (iv)	100%	100%	100% (iv)	100%	100%	100%
Thermal conductivity - λ _{23/80} W/(m·K) (i)		ND	ND	ND	ND	ND	ND	ND	ND
Thermal resistance - R _{23/80} (m ² ·K)/W (i)		ND	ND	ND	ND	ND	ND	ND	ND
(i) Rendering system applied on the Glasroc® X board (EB1). (ii) Values from initial immersion. (iii) Values from 3 minutes immersion. (iv) Rendering system variant not tested. Maximum values have been defined. (v) Rendering system variant not tested. Minimum values have been defined. ND = Not defined by the manufacturer.									

Generic component	Code	Trade name	Reference
Finishing coat	FC1	webertene classic L (Spain) - webercote acrylcover M (Italy) - webertene stilo /cromasil (Others)	EN 15824
	FC2	webertene classic XL (Spain) - webercote acrylcover G (Italy) - webertene geos (Others)	EN 15824
	FC3	webertene advance S (Spain) - webercote siloxcover F (Italy)- webertene micro (Others)	EN 15824
	FC4	webertene advance M (Spain) - webercote siloxcover R (Italy) - webertene habitat (Others)	EN 15824
	FC5	webercote acrylcover R (Italy)	EN 15824
Primer (before finishing coat)	P1	webertene primer (CS plus)	EN 1062-1
	P2	RA13 (Italy)	EN 1062-1
	P3	RC14 (Italy)	EN 1062-1
Base-coat	BC1	webertherm base	EN 998-1
	BC2	webertherm flex B	EN 15824
	BC3	webertherm AP 60 TOP F	EN 998-1
Reinforcement mesh	M1	webertherm mesh 160	ETA 13/0392

Rendering systems
Technical description

Annex A2
of European Technical
Assessment ETA 21/1049

Characteristics	Reference	FC1	FC2	FC3	FC4	FC5
Trade name	---	See table A2.2	See table A2.2	See table A2.2	See table A2.2	See table A2.2
Generic type	EN 15824	(*)	(*)	(*)	(*)	(*)
Range of application thickness (mm)	---	2,0 – 3,0	2,5 – 3,0	1,0 – 2,0	1,5 – 2,0	1,5 – 2,0
Coverage (kg/m ² per 1 mm thickness)	---	≤ 1,6	≤ 1,7	≤ 1,5	≤ 1,4	≤ 1,5
Particle size (%)	A.4 of EAD 090119-00-0404	1,5	2,5	0,8	1,2	1,2
Weight (kg) as delivery	---	25 ± 0,5 per bucket (paste)	25 ± 0,5 per bucket (paste)	25 ± 0,5 per bucket (paste)	25 ± 0,5 per bucket (paste)	25 ± 0,5 per bucket (paste)
Density of hardened mortar (kg/m ³)	A.3.3 of EAD 090119-00-0404	1700 - 1800	1750 - 1850	1750 - 1850	1750 - 1850	1700 - 1800
Static modulus of elasticity at break (MPa)	A.7 of EAD 090119-00-0404	0,51	0,46	0,33	ND	ND
Tensile strength at break (MPa)		> 0,9 (on plaster); > 0,3 following EN1542)	> 0,9 (on plaster); > 0,3 following EN1542)	> 0,7 (on plaster); > 0,3 following EN1542)	> 0,7 (on plaster); > 0,3 following EN1542)	> 0,9 (on plaster); > 0,3 following EN1542)
Elongation at break (%)		2,50	3,14	0,93	ND	ND
Water absorption (kg/m ² .h ^{0,5})	EN 1062-3	W2	W2	W2	W2	W2
Water vapour permeability, Sd (m)	EN ISO 7783	V2 sd ≥ 0,14 sd < 1,40	V2 sd = 0,25	V1 sd = 0,11	V1 sd = 0,11	V2 sd = 0,25
Dry extract – paste (%)	A.5 of EAD 090119-00-0404	80 - 89	80 - 89	80 – 89	80 – 89	80 – 89
Ash content (%) at 450 °C	A.6.1 of EAD 090119-00-0404	76 - 80	ND	74 - 78	75 - 79	76 - 80
Organic content (%)	---	11 - 12	11 - 12	11 - 12	11 - 12	11 - 12
PCS _S -value (MJ/kg)	EN ISO 1716	≤ 3,10	≤ 3,10	≤ 3,10	≤ 2,50	≤ 2,50
Reaction to fire	EN 13501-1	A2-s1,d0	A2-s1,d0	A2-s1,d0	A2-s1,d0	A2-s1,d0
Thermal conductivity λ _{10,drv(p=50%)} (W/m·K)	EN 1745	1,17	1,10	1,00	1,10	1,13

ND = Not defined by the manufacturer.
 (*) Renders and internal plasters based on organic binders.
 "----" = not applicable.

Characteristics	Reference	P1	P2	P3
Trade name	---	webertene primer (CS Plus)	RA13 (Italy)	RC14 (Italy)
Generic type	EN 1062-1	Aqueous dispersion of synthetic resins resistant to alkalis	Aqueous dispersion of synthetic resins resistant to alkalis	Aqueous dispersion of synthetic resins resistant to alkalis
Range of application thickness (mm)	---	≤ 0,2	≤ 0,05	≤ 0,05
Coverage (kg/m ² per 1 mm thickness)	---	≤ 0,5	≤ 0,5	≤ 0,5
Density of delivered product – liquid (kg/m ³)	A.3.1 of EAD 090119-00-0404	1550 ± 95	1000 ± 50	1150 ± 50
Dry extract – liquid (%)	A.5 of EAD 090119-00-0404	65 ± 3	52 ± 5	10.4 ± 3
Ash content (%) at 450 °C	A.6.1 of EAD 090119-00-0404	50 ± 2	14 ± 2	2 ± 1
PCS _S -value (MJ/kg)	EN ISO 1716	6,68	ND	ND

ND = Not defined by the manufacturer.
 "----" = not applicable.

Rendering systems
 Technical description

Annex A2
 of European Technical
 Assessment ETA 21/1049

Characteristics		Reference	BC1	BC2	BC3
Trade name		---	webertherm base	webertherm flex B	webertherm AP 60 TOP F
Designation		EN 998-1	GP – General purpose rendering/plastering mortar	---	GP – General purpose rendering/plastering mortar
		EN 15824	---	Renders and internal plasters based on organic binders	---
Range of application thickness (mm)		---	3 – 6	3 – 5	3 -4
Coverage (kg/m ² per 1 mm thickness)		---	≤ 1,5	1,5 – 2,0	1,5 – 2,0
Density of delivered product (kg/m ³)		EN 1015-6 or A.3.1 of EAD 090119-00-0404	1200 – 1400 (powder)	1700 ± 170 (paste)	1300 – 1400 (powder)
Weight per bag (kg) as delivery (dry mortar)		---	25 ± 1	---	25 ± 0,25
Water-product ration		---	5,5 – 6,5 litres per bag (25 kg)	---	5,0 – 5,5 litres per bag (25 kg)
Particle size (%)		A.4 of EAD 090119-00-0404	≤ 1,0	≤ 0,5	≤ 0,6
Density of hardened mortar (kg/m ³)		EN 1015-10	1300 - 1500	1100 - 1300	1350 - 1450
Water absorption (kg/m ² .min ^{0,5})		EN 1015-18	W2 (≤ 2)	---	W2
Water vapour resistance factor, μ		EN 1015-19	≤ 10	ND	≤ 30
Flexural strength (MPa)		EN 1015-11	≥ 2,0	---	≥ 2,0
Compressive strength (MPa)			≥ 3,5 (CSIII)	---	≥ 10,0 (CSIV)
Static modulus of elasticity at break (MPa)		A.7 of EAD 090119-00-0404	< 7000	10,1	7000
Elongation at break (%)			---	2	---
Shrinkage - 28 d (mm/m)		A.7.1 of EAD 090119-00-0404	< 2	---	---
Dry extract – paste (%)		A.5 of EAD 090119-00-0404	---	81,5 ± 4,0	---
Ash content (%) at 450 °C		A.6.1 of EAD 090119-00-0404	90 ± 1	86,5 ± 1,3	95,5 – 96,5
PCS _S -value (MJ/kg)		EN ISO 1716	0,59	2,35	0,2 (referred to the similar product but with a 1,4 mm grain size)
Water absorption by capillarity (kg/m ²) (*)	after 3 min. (**)	Annex E of EAD 090119-00-0404	0,10	0,02	0,170
	after 1 h. (***)		0,12	0,01	0,082
	after 24 h. (***)		0,59	0,07	0,501
Bond strength (MPa) (*)	Mean	EN 1015-12	0,24	0,30	0,35
	Minimum		0,21	0,21	0,27
	Cohesive rupture		100%	100%	100%
(*) Base-coat applied on the Glasroc® X board (GX).					
(**) Values from initial immersion.					
(***) Values from 3 minutes immersion.					
ND = Not defined by the manufacturer.					
“---” = not applicable.					

Table A2.6: REINFORCEMENT MESH.			
Characteristics		Reference	M1
Trade name		---	webertherm mesh 160 (webertherm RE160)
Designation		ETA 13/0392	R 131 A101
Generic type			Glass fibre reinforcing mesh
Thickness (mm)			0,52 ± 0,20
Mass per unit area (g/m ²)			160 ± 5
Ash content (%) at 625 °C			82 ± 1
Organic content (%)		A.6.2 of EAD 090119-00-0404	20 ± 4
Mesh size (mm)		ETA 13/0392	3,5 x 3,8
Tensile strength (N/mm)	without ageing		≥ 36
	after conditioning		≥ 20
	residual (%)		≥ 50
Elongation (%) in standard conditions			3,8
PCS ₅ -value (MJ/kg)		EN ISO 1716	4,49
ND = Not defined by the manufacturer. "---" = not applicable.			

ANNEX 3 - BOARD LAYER

Table A3.1: Trade name of external layer components.

Generic component	Code	Trade name	Reference
External board	EB1	Glasroc® X board	EN 15283-1
Joint filler for Glasroc® X board	EJF1 = BC1	webertherm base	EN 998-1
	EJF2 = BC2	webertherm flex B	EN 15824
	EJF3 = BC3	webertherm AP 60 TOP F	EN 998-1
Joint tape for Glasroc® X board	EJT1 = M1	webertherm mesh 160 (cut 10 cm)	ETA 13/0392
External board-fixings	for aluminium alloy subframe Fix1	THTPF INOX (drill point)	EN 14566

ND = Not defined by the manufacturer.

Table A3.2: BOARD.

Characteristics	Reference	EB1
Trade name	---	Glasroc® X board
Designation		GM-FH1
Thickness (mm)	EN 15283-1	12,5 ± 0,7
Width (mm)		≤ 1200
Length (mm)		≤ 3000
Density (kg/m ³)	EN 520	832 - 944
Mass per unit area (kg/m ²)	---	10,4 – 11,8
Breaking load (N)	EN 15283-1	Longitudinal ≥ 540
		Transversal ≥ 210
Board fixing pull-through design load (N)		≥ 300
Water absorption	EN 15283-1	Partial (g/m ² in 2 h) < 100
		Total (%) < 5
Water vapour resistance factor, μ	EN 15283-1	18,2
Dimensional stability by humidity	EN 12467	< 0,005
Linear thermal expansion (mm/m·°C)	EN 14581	0,008
PCS _S -value (MJ/kg)	EN ISO 1716	2,99
Reaction to fire	EN 13501-1	A1
Thermal conductivity (W/(m·K))	EN 10456	0,30
Board fixings distance range (mm)	---	Between 150 mm to 250 mm

ND = Not defined by the manufacturer.

"---" = not applicable.

Table A3.3: FIXINGS FOR GLASROC® X BOARD.

Characteristics	Reference	Fix1
Trade name	---	THTPF INOX
Generic type	EN 14566	Drywall self-drilling screw for aluminium profile thickness up to 2,00 mm
Diameter x length (mm)	---	4,8 x 32
		4,8 x 25
Pin shape	---	Drill point
Material type	EN ISO 3506-1	Stainless steel A2-70
Reaction to fire	EN 13501-1	A1

ND = Not defined by the manufacturer.

"---" = not applicable.

ANNEX 4 - SUBFRAMES

A4.1 - ALUMINIUM ALLOY SUBFRAME COMPONENTS

These components are not part of the kit but of the assembled system. They are not supplied by the kit manufacturer, however, they are available on the market and they have to meet the specifications indicated in the subsequent table.

Components		ASF1		
Vertical profile	Shape	T-profile	L-profile	
	Aluminium alloy type	AW 6063 / AW 6005 / AW 6060 AW 6063 T5 or greater resistance aluminium alloy		
	Durability class	B		
	Minimum dimensions	Thickness (mm)	≥ 1,8	
		Web width (mm)	≥ 60	
		Flange width (mm)	≥ 80	≥ 40
	Minimum cross-section (mm ²)	≥ 224	≥ 154	
	Minimum moment of inertia	I _{xx} (cm ⁴)	≥ 8,0	≥ 6,0
		I _{yy} (cm ⁴)	≥ 7,0	≥ 2,0
	Span between two vertical profiles (mm)	600		
Maximum length by façade area (m)	6,0			
Supporting bracket	Aluminium alloy type	AW 6063 / AW 6005 / AW 6060		
	Minimum dimensions	Thickness (mm)	≥ 2,5	
		Height length (mm)	≥ 160	
	Minimum resistance	Vertical load (kN)	≥ 2,50	
Horizontal load (kN)		≥ 1,9		
Retaining bracket	Aluminium alloy type	AW 6063 / AW 6005 / AW 6060		
	Minimum dimensions	Thickness (mm)	≥ 2,5	
		Height length (mm)	≥ 80	
	Minimum resistance	Horizontal load (kN)	≥ 3,8	
Maximum distance between two brackets in the same profile (m)	1,5			
Fixing between profiles and brackets	Generic type	Self-drilling screw with hexagon head and integrated washer		
	Material	Stainless steel (A2 or A4)		
	Minimum diameter (mm)	Fastener	≥ 5,5	
		Washer	≥ 13,0	
Minimum length (mm)	≥ 19,0			
Fixings between brackets and substrate	Generic type	The fixings between brackets and substrate must be chosen taking into account the substrate material (e.g. normal concrete, cracked concrete, masonry, steel structure, etc.) and also the minimum specifications indicated in this table.		
	Minimum diameter (mm)	Fastener	≥ 6,0	
		Washer	≥ 16,0	
	Material (*)	Stainless steel (A2 or A4)		
	Minimum pull-out strength (**)	≥ 2,5 kN or greater than the reaction due to wind load.		
	Minimum shear strength	≥ 2,0 kN or greater than the reaction due to dead load.		
Other	Reference	The fixings between the brackets and the substrate may be CE marked according to an ETA on the basis of the relevant EAD as long as this CE marking is mandatory in the Member State where the kit is used.		
	Serviceability	The serviceability conditions such as load directions, material of substrate (concrete type, masonry type, etc.), minimum distance to edges, etc. must be taken into account.		
(*) The fixing material must guarantee the electrochemical compatibility between the different materials.				
(**) Minimum pull-out strength must be guaranteed on substrate material.				

ANNEX 5 - SYSTEM OPTIONAL COMPONENTS

A5.1 - FLEXIBLE SHEET FOR WATERPROOFING (OPTIONAL)

These components are not part of the kit but of the assembled system. They are not supplied by the kit manufacturer, however, they are available on the market and they have to meet the specifications indicated in the subsequent table.

Table A5.1.1: Trade name of flexible sheet for waterproofing.

Generic component	Code	Trade name	Reference
Flexible sheet for waterproofing	WPL-1	R.F sheet (Dupont™ Tyvek® 2066B)	EN 13859-2
	WPL-2	Standard sheet (Dupont™ Tyvek® 1060B)	

Table A5.1.2: FLEXIBLE SHEET FOR WATERPROOFING (OPTIONAL).

Characteristic		Reference	WPL-1	WPL-2
Trade name		---	R.F sheet. (Dupont™ Tyvek® 2066B)	Standard sheet (Dupont™ Tyvek® 1060B)
Generic type		EN 13859-2	Water vapour permeable water barrier	
Thickness (µm)			175	
Mass per unit area (g/m ²)		EN 1849-2	68 ± 6	60 ± 5
Reaction to fire		EN 13501-1	B-s1,d0	E
Water vapour transmission – Sd (m)		EN ISO 12572	≤ 0,025	
Watertightness		EN 1928 (method A)	W1	W1
Water column (m)		EN 20811	1,3	1,5
Maximum tensile strength (N) per 50 mm		EN 12311-1	MD: 300 ± 50 XD: 300 ± 50	MD: 310 ± 50 XD: 310 ± 50
Elongation at maximum tensile strength (%)			MD: 16 ± 5 XD: 18 ± 5	MD: 17 ± 5 XD: 20 ± 5
Resistance to tearing - nail shank (N)		EN 12310-1	MD: 50 ± 20 XD: 50 ± 20	MD: 55 ± 20 XD: 50 ± 20
Artificial ageing by UV and heat (Relative values: after/before aged)	Maximum tensile strength (%)	EN 1297 & EN 1296 EN 12311-1	MD: 240 ± 50 XD: 240 ± 60	MD: 80 XD: 80
	Elongation at maximum tensile strength (%)		MD: 10 ± 4 XD: 12 ± 5	MD: 70 XD: 70
	Watertightness	EN 1297 & EN 1296 EN 1928 (method A)	W1	W1
MD = machine direction (longitudinal). XD = transverse (cross) direction. “---” = not applicable.				

Flexible sheet for waterproofing
Technical description

Annex A5.1
of European Technical
Assessment ETA 21/1049

A5.2 - MINERAL WOOL THERMAL INSULATION (OPTIONAL)

These components are not part of the kit but of the assembled system. They are not supplied by the kit manufacturer, however, they are available on the market and they have to meet the specifications indicated in the subsequent table.

Generic component	Reference
Thermal insulation for non-ventilated cladding systems	EN 13162
Thermal insulation for ventilated cladding systems (*)	EN 13162
(*) Thermal insulation material in a system of ventilated façades must be rigid and properly fixed in order to prevent tearing and dispersion of the material due to any strong air flow in the ventilated air-space. Greater density of insulation material also prevents the infiltration of cold air into the material.	

Characteristics	Reference	For non-ventilated cladding system	For ventilated cladding system (*)
Generic type	EN 13162	Mineral Wool (MW)	
Thickness (mm)	EN 823	40 – 130 (minimum tolerance T3)	
Short term water absorption by partial immersion (kg/m ²)	EN 1609	< 1,0	
Long term water absorption by total immersion (%)	EN 12087	< 5,0	
Dimensional stability under specified temperature, 23 °C, and humidity condition, 90 % RH (%)	EN 1604	---	$\Delta\epsilon_i$; $\Delta\epsilon_b$; $\Delta\epsilon_d$ < 1,0 (%)
Reaction to fire	EN 15301-1	A1	
Water vapour permeability - μ	EN ISO 10456	$\mu = 1$	
Airflow resistivity (kPa·s/m ³)	EN 29053	≥ 5	
Thermal conductivity and thermal resistance - λ_D (W/(m·K))	EN 13162	$\leq 0,038$	
Durability	EN 13162	Acceptable for reaction to fire and thermal conductivity	
(*) Thermal insulation material in a system of ventilated façades must be rigid and properly fixed in order to prevent tearing and dispersion of the material due to any strong air flow in the ventilated air-space. Greater density of insulation material also prevents the infiltration of cold air into the material. “---” = not applicable.			

ANNEX 6 - CONSTRUCTION DETAILS

Legend (for all figures in Annex 6):

1. Substrate.
2. Bracket.
3. Fixing between brackets and substrate.
4. Vertical profile.
5. Fixing between profile and bracket.
6. Thermal insulation (MW) (optional).
7. Thermal insulation fixing (optional).
8. Air camera.
9. Flexible sheet for waterproofing (optional).
10. Glasroc® X.
11. Fixing between board and profile.
12. Rendering system.
13. Roof edge flashing.
14. Perforated metallic sheet.
15. Join profile.
16. Ancillary profile.

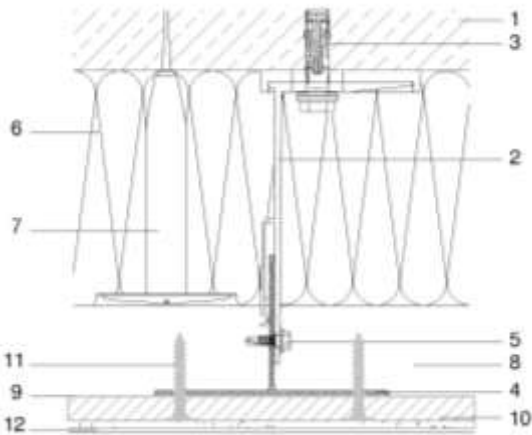

Figure A6.1: Standard horizontal cross-section.

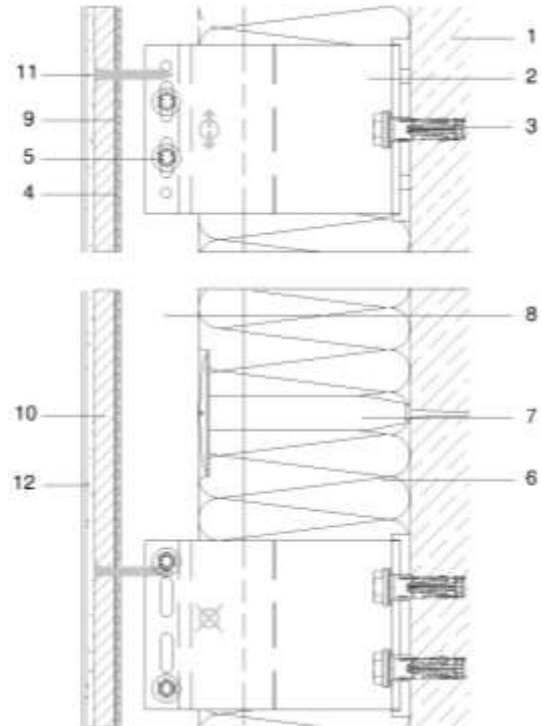

Figure A6.2: Standard vertical cross-section.

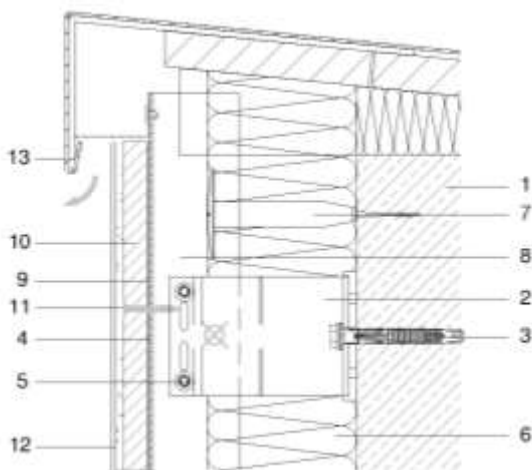

Figure A6.3: Roof edge (ventilated cladding system).

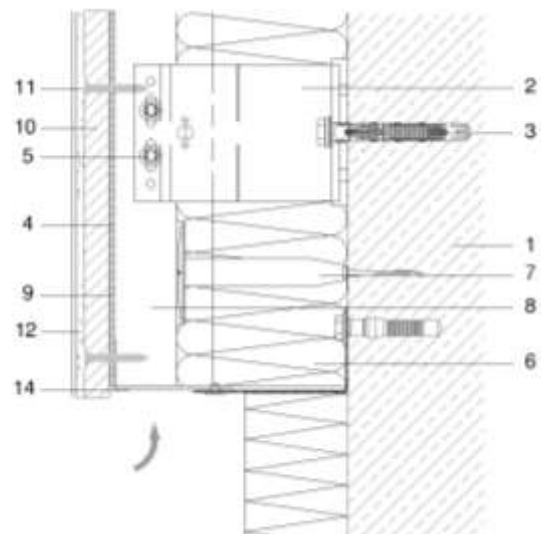

Figure A6.4: Base edge (ventilated cladding system).

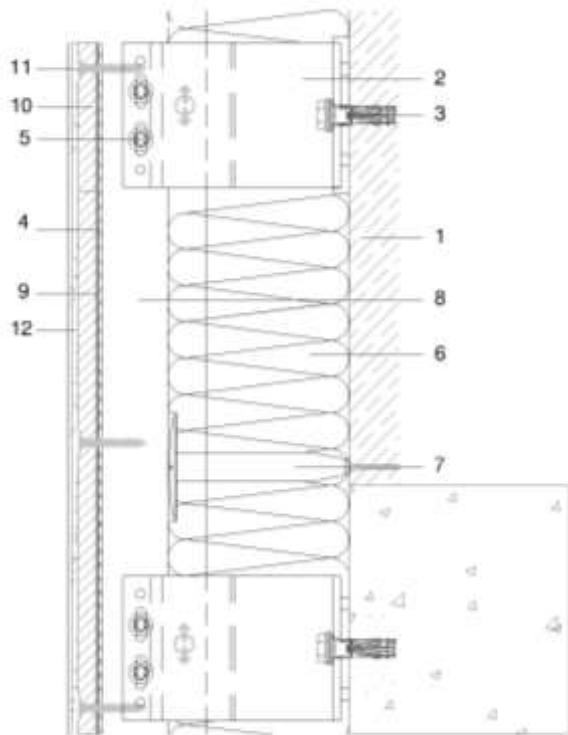

Figure A6.5: Connexion with building structure.

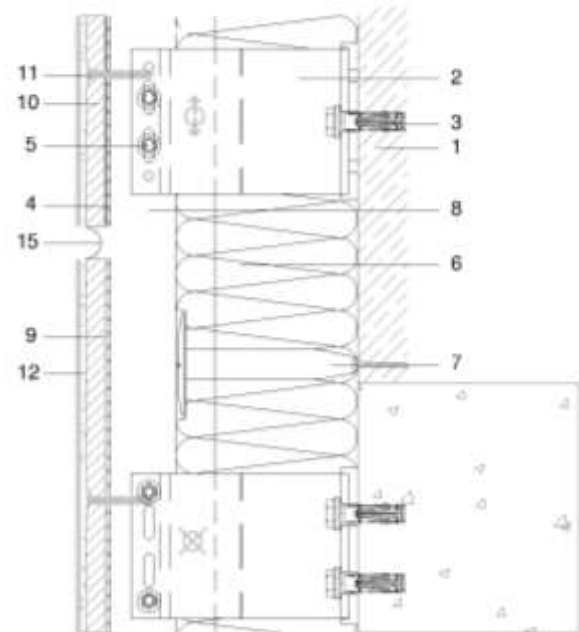

Figure A6.6: Horizontal control joint.

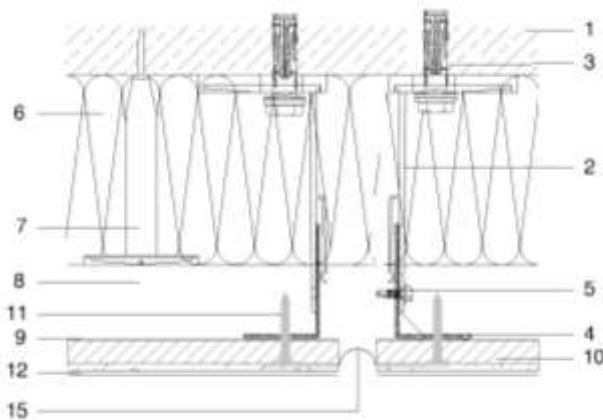

Figure A6.7a: Vertical control joint.

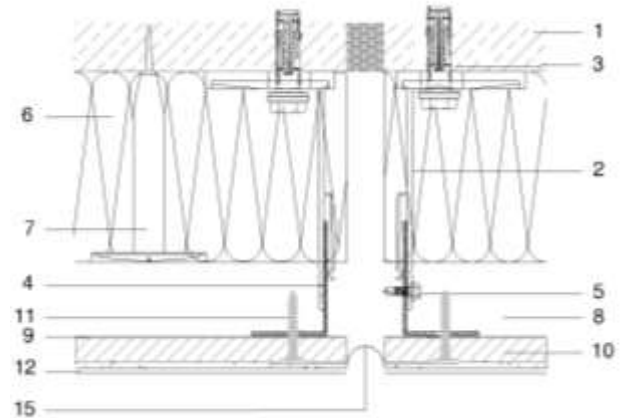

Figure A6.7b: Vertical movement joint (including building structure).

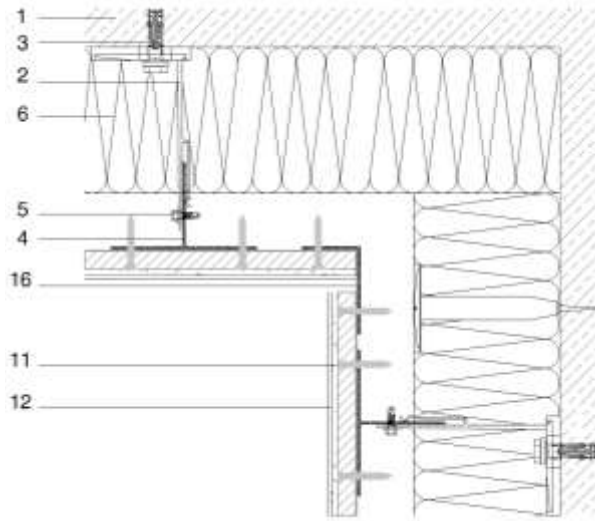

Figure A6.8a: Convex corner.

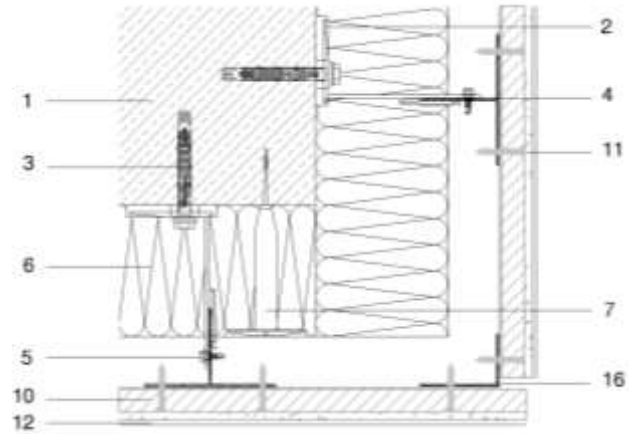

Figure A6.8b: Concave corner.

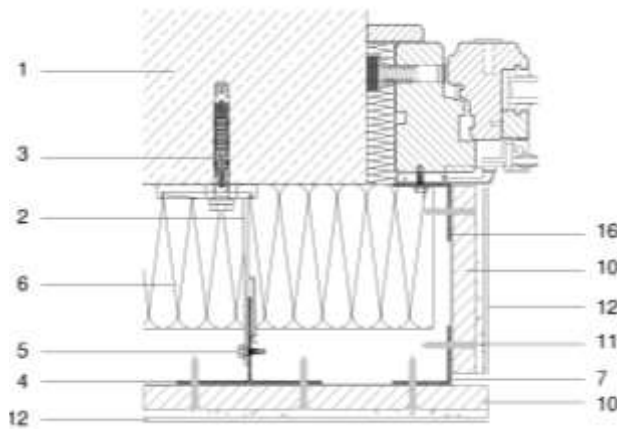

Figure A6.9: Jamb.

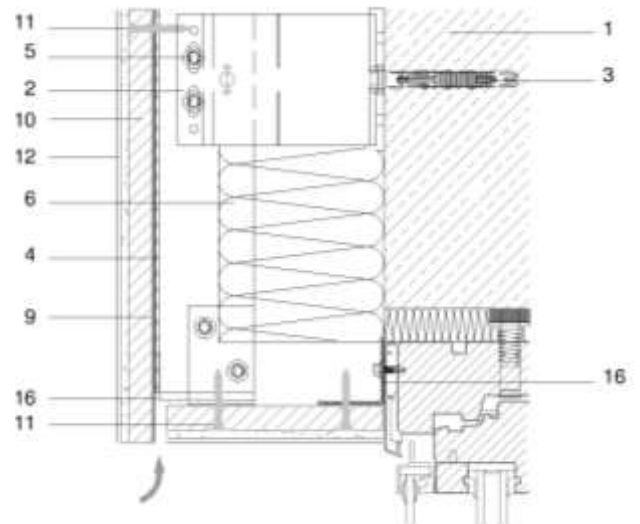

Figure A6.10a: Lintel with Glasroc® X board.

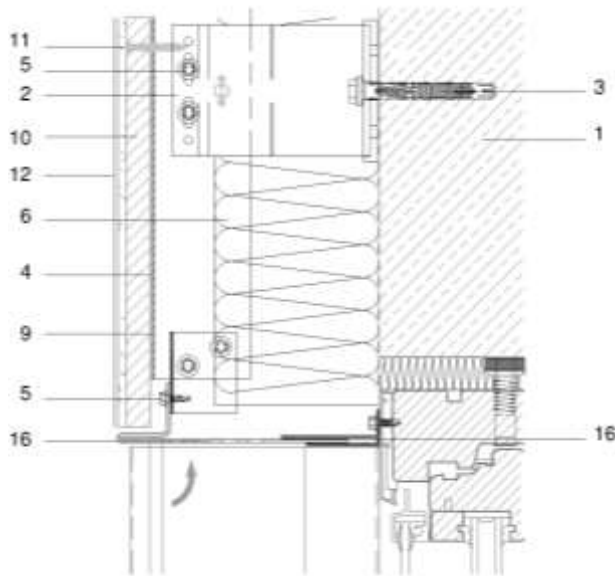

Figure A6.10b: Lintel with metal profile.

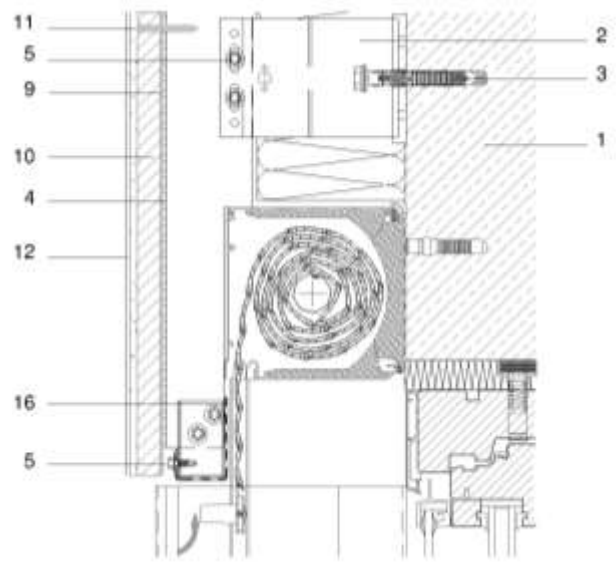

Figure A6.10c: Lintel with shutter box.

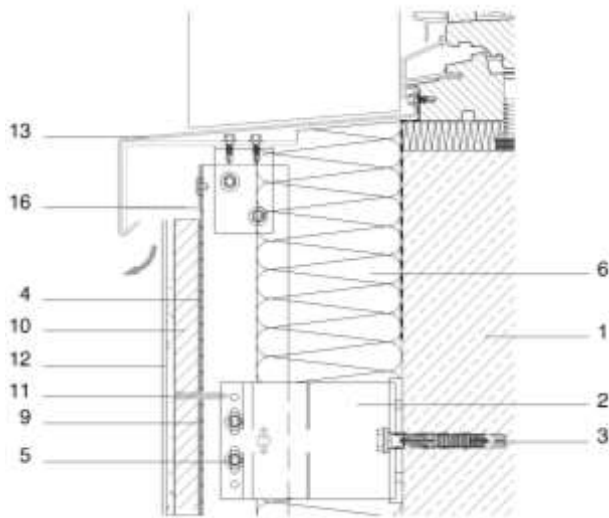

Figure A6.11: Sill.

ANNEX 7 - DESIGN, INSTALLATION, MAINTENANCE AND REPAIR CRITERIA

A7.1 Design

The design of the external wall cladding systems with renderings applied in situ for ventilated and non-ventilated façades using the kits defined in this ETA should observe the following criteria:

- The assembled system design must be checked by calculation taking into account the mechanical characteristic values of relevant components (boards, profiles, brackets and fixings) in order to verify that they resist the relevant actions (dead loads, wind loads, etc.) applying on the specific works. National safety factors must be used.
- The distance between vertical profiles must be 600 mm or 400 mm.
- The design must also accommodate the specified thermal movements of components and also structural movements of the substrate without inducing damage to the assembled system or components.
- The assembled system design must be based on the standard construction details given in Annex 6. For specific conditions of the works, other solutions could be used taking into account the following aspects:
 - The weakest points of the façade are the continuity of the rendering system on the board, the connections with the openings, the base edges and the roof edges, therefore the design of these points requires special attention.
 - Flexible sheet of waterproofing is an optional component. However, in general, the use of flexible sheet of waterproofing in the assembled system is recommended by the ETA holder
 - Besides, the use of the thermal insulation in the assembled system is also recommended by the ETA holder.
- Corrosion protection of subframe components must be chosen taking into account the category of corrosivity of the atmosphere (see EN ISO 9223) in which will be the works.
- Fixings between brackets and the substrate must be chosen according to the substrate material and the minimum resistance required due to maximum envisaged wind load and dead load (pull-out and shear strength of fixings).
- The assessment of risk of water condensation of the façade complete solution (e.g. by means of EN ISO 13788) must distinguish between ventilated or non-ventilated façade.

A7.2 Installation

The installation of the external wall cladding systems with renderings applied in situ for ventilated and non-ventilated façades using the kits defined in this ETA should observe the following criteria:

- The installation of the kits must be carried out in accordance with ETA holder instructions and the design and drawings prepared for the specific works. It is the responsibility of the ETA holder to ensure that the information on these provisions is given to those concerned.
- Special attention is required for the installation of the weakest points of the façade (continuity of the rendering system, opening connections, the base edges and the roof edges).
- The installation of the kits must be carried out by installation companies and by installation staff which have been trained and authorized by the ETA holder.

A7.3 Maintenance and repair

Maintenance of the assembled systems or kit components includes inspections on site, taking into account the following aspects:

- Regarding the rendering systems and Glasroc® X board: the appearance of any damage such as cracking, detachment, delamination, mould presence due to permanent moisture or permanent irreversible deformation.
- Regarding the subframe components: the presence of corrosion or presence of water accumulation.

When necessary, any repair to localised damaged areas must be carried out with the same kit components and following the repair instructions given by the ETA holder.