



**The Catalonia
Institute of Construction
Technology**

Wellington 19
ES-08018 Barcelona
Tel. +34 93 309 34 04
qualprod@itec.cat
itec.cat



European Technical Assessment

**ETA 21/0424
of 16.07.2021**



General part

Technical Assessment Body issuing the ETA: ITeC

ITeC has been designated according to Article 29 of Regulation (EU) No 305/2011 and is member of EOTA (European Organisation for Technical Assessment).

Trade name of the construction product

FX-EP 5

Product family to which the construction product belongs

Bonded fasteners for use in concrete.

Manufacturer

FASTFIX-IT ENTERPRISE CO., LTD
No. 47-1, Lane 199, Renxin Rd.
814 Renwu District (Kaohsiung City)
Taiwan

Manufacturing plant(s)

FASTFIX-IT ENTERPRISE CO., LTD
No. 47-1, Lane 199, Renxin Rd.
814 Renwu District (Kaohsiung City)
Taiwan

This European Technical Assessment contains

22 pages including 3 annexes which form an integral part of this assessment.

This European Technical Assessment is issued in accordance with Regulation (EU) 305/2011, on the basis of

European Assessment Document EAD 330499-01-0601.

General comments

Translations of this European Technical Assessment in other languages shall fully correspond to the original issued document.

Communication of this European Technical Assessment, including transmission by electronic means, shall be in full (excepted the confidential Annex(es)).

Specific parts of the European Technical Assessment

1 Technical description of the product

FX-EP 5 is a bonded fastener consisting of a solvent-free, epoxy-based resin, two-part high-performance anchoring adhesive and a steel element. Steel elements can be zinc coated steel or stainless steel threaded rods and rebars.

The steel element is placed into a drilled hole filled with resin. The steel element is anchored via the bond between the metal part, resin and concrete. The anchor is intended to be used with a range of diameters from 8 mm to 32 mm.

The illustration and the description of the product are given in Annex A.

2 Specification of the intended use(s) in accordance with the applicable EAD

The performances given in Section 3 are only valid if the anchor is used in compliance with the specifications and conditions given in Annex B.

The provisions made in this ETA are based on a working life of FX-EP 5 of at least 50 years, provided that the conditions laid down in the manufacturer's instructions for the installation, use and maintenance are met. These provisions are based upon the current state of the art and the available knowledge and experience.

The indications given as to the working life of the product cannot be interpreted as a guarantee but are regarded only as a means for choosing the appropriate products in relation to the expected economically reasonable working life of the works.

3 Performance of the product and reference to the methods used for its assessment

3.1 Performance of the product

The assessment of FX-EP 5 has been performed in accordance with EAD 330499-01-0601 for *Bonded fasteners for use in concrete*.

Basic requirement	Essential characteristic	Performance
BWR 1 Mechanical resistance and stability	Characteristic resistance to tension load (static and quasi-static loading)	See Annex C.1 and C.2
	Characteristic resistance to shear load (static and quasi-static loading)	See Annex C.3 and C.4
	Displacements under short-term and long-term loading	See Annex C.5 and C.6
	Characteristic resistance and displacements for seismic performance categories C1 and C2	No performance assessed
BWR 3 Hygiene, health and the environment	Content, emission and/or release of dangerous substances.	No performance assessed

Table 3.1: Performance of the product.

3.2 Methods used for the assessment

3.2.1 Characteristic resistance to tension load (static and quasi-static loading)

Tests and calculations have been performed according to EAD 330499-01-0601, clauses 2.2.1 to 2.2.6.

3.2.2 Characteristic resistance to shear load (static and quasi-static loading)

Tests and calculations have been performed according to EAD 330499-01-0601, clauses 2.2.7 to 2.2.9.

3.2.3 Displacements under short-term and long-term loading

Tests and calculations have been performed according to EAD 330499-01-0601, clause 2.2.10.

4 Assessment and verification of constancy of performance (AVCP) system applied, with reference to its legal base

According to the Decision 1996/582/EC of the European Commission the system of AVCP (see EC delegated Regulation (EU) No 568/2014 amending Annex V to Regulation (EU) 305/2011) given in the following table applies.

Table 4.1: AVCP system.

Product(s)	Intended use(s)	System
Metal anchors for use in concrete	For fixing and/or supporting to concrete, structural elements (which contributes to the stability of the works) or heavy units	1

5 Technical details necessary for the implementation of the AVCP system, as foreseen in the applicable EAD

All the necessary technical details for the implementation of the AVCP system are laid down in the *Control Plan* deposited with the ITeC and agreed in accordance with EAD 330499-01-0601, section 3.

The *Control Plan* is a confidential part of the ETA and only handed over to the notified product certification body involved in the assessment and verification of constancy of performance.

The factory production control operated by the manufacturer shall be in accordance with the above-mentioned *Control Plan*.

Issued in Barcelona on 16th July 2021

by the Catalonia Institute of Construction Technology.



Technical Director, ITeC

Annex A: Product description

Annex A.1: Installed conditions

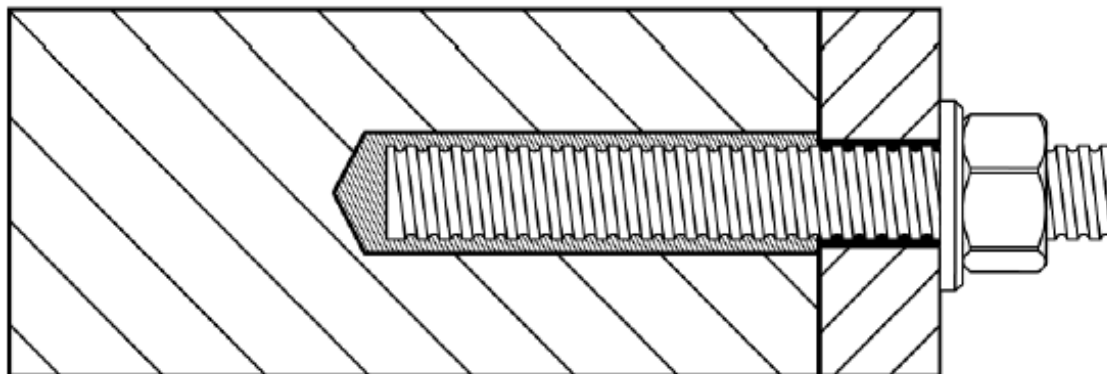

Figure A.1.1: Threaded rod.

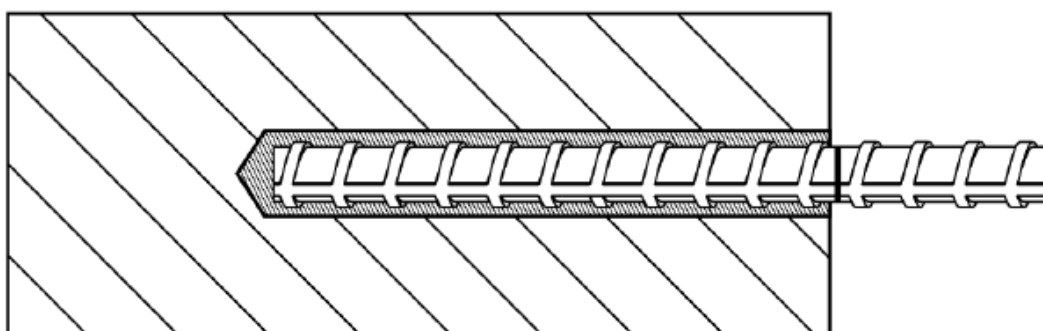

Figure A.1.2: Reinforcing bar (rebar).

Annex A.2: Injection system

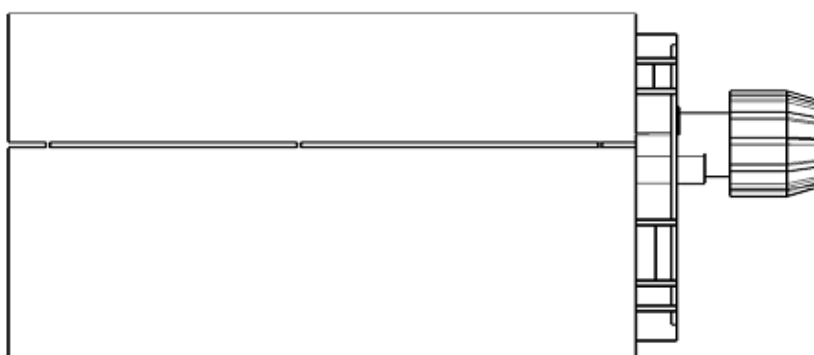

Figure A.2.1: Injection cartridge FX-EP5 (585 ml).

The marking of the cartridges should include the identifying mark of the producer, the trade name, the charge code number, storage life, and curing and processing time.



Figure A.2.2: Mixing nozzle.

Annex A.3: Resin

Part	Chemical characterisation	Density
Part A	Epoxy resins	1,70 kg/l
Part B	Polyamines with inorganic fillers	1,30 kg/l
Mixing Part A / Part B = 3 / 1 by volume	Epoxy based resin with polyamines with inorganic fillers	1,68 kg/l

Table A.3.1: Resin and components characterisation.

Annex A.4: Threaded rod

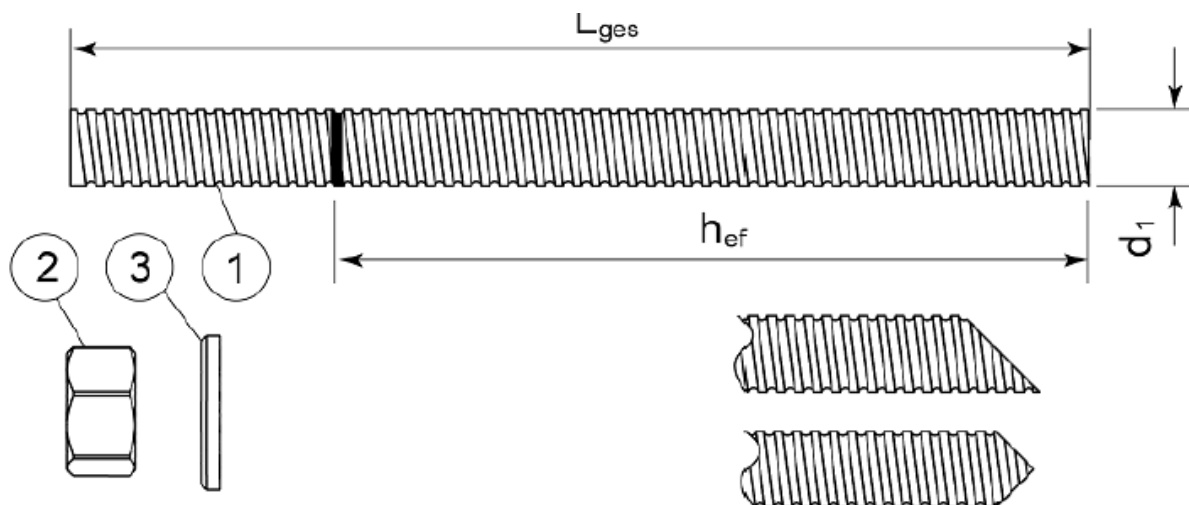

Figure A.4.1: Threaded rod M8, M10, M12, M16, M20, M24, M27, M30.

Standard commercial threaded rod with marked embedment depth.

Part	Designation	Material
Steel, zinc plated $\geq 5 \mu\text{m}$ acc. to EN ISO 4042 or Steel, Hot-dip galvanised $\geq 40 \mu\text{m}$ acc. to EN ISO 1461 and EN ISO 10684 or Steel, zinc diffusion coating $\geq 15 \mu\text{m}$ acc. to EN ISO 17668		
1	Anchor rod	Steel, EN ISO 683-4 or EN 10263 Property class 4.6, 5.8, 8.8, 10.9 EN ISO 898-1
2	Hexagon nut EN ISO 4032	According to threaded rod
3	Washer EN ISO 887, EN ISO 7089, EN ISO 7093 or EN ISO 7094	According to threaded rod
Stainless steel		
1	Anchor rod	Material: A2-70, A4-70, A4-80, EN ISO 3506
2	Hexagon nut EN ISO 4032	According to threaded rod
3	Washer EN ISO 887, EN ISO 7089, EN ISO 7093 or EN ISO 7094	According to threaded rod
High corrosion resistant steel		
1	Anchor rod	Material: 1.4529, 1.4565, EN 10088-1
2	Hexagon nut EN ISO 4032	According to threaded rod
3	Washer EN ISO 887, EN ISO 7089, EN ISO 7093 or EN ISO 7094	According to threaded rod

Table A.4.1: Specification of threaded rod and materials.

Annex A.5: Rebar**Figure A.5.1:** Rebar Ø10, Ø12, Ø16, Ø20, Ø25, Ø32.

Standard commercial reinforcing bar with marked embedment depth.

Product form		Bars and de-coiled rods	
Class		B	C
Characteristic yield strength f_{yk} or $f_{0,2k}$ (MPa)		400 to 600	
Minimum value of $k = (f_t/f_y)_k$		$\geq 1,08$	$\geq 1,15$ $< 1,35$
Characteristic strain at maximum force ϵ_{uk} (%)		$\geq 5,00$	$\geq 7,5$
Bendability		Bend/Rebend test	
Maximum deviation from nominal mass (individual bar) (%)	Nominal bar size (mm)		
	≤ 8	$\pm 6,0$	
	> 8	$\pm 4,5$	
Bond: Minimum relative rib area, $f_{R,min}$	Nominal bar size (mm)		
	8 to 12	0,040	
	>12	0,056	

Table A.5.1: Specification of rebars and materials.

Annex B: Intended use

Annex B.1: Specifications of intended use

Option 7 of table 1.1 of EAD 330499-01-0601 applies.

Anchorage subject to:

- Static load and quasi-static load.

Base materials:

- Non-cracked concrete.
- Reinforced or unreinforced normal weight concrete of strength class C20/25 at minimum and C50/60 at maximum according to EN 206:2013+A1:2018.

Temperature range:

- Service temperature: T1 - +24°C to +40°C = temperature range from -40°C to +40°C (max. short-term temperature +40°C and max. long-term temperature +24°C).
- Installation temperature: +10°C to +40°C.

Use conditions (environmental conditions)¹:

- Structures subject to dry internal conditions (zinc coated steel, stainless steel, high corrosion resistance steel).
- Structures subject to external atmospheric exposure including industrial and marine environment, if no particular aggressive conditions exist (stainless steel A4, high corrosion resistance steel).
- Structures subject to permanently damp internal condition, if no particular aggressive conditions exist (stainless steel A4, high corrosion resistance steel).
- Structures subject to permanently damp internal condition, with particular aggressive conditions exist (high corrosion resistance steel).

Installation:

- I2 – installation in water-filled drill holes (not sea water) and use in service in dry or wet concrete.
- D2 – downward and horizontal installation.
- Hole drilling by rotary hammer (electric drilling machine or driven by compressed air).
- Anchor installation carried out by appropriately qualified personnel and under the supervision of the person responsible for technical matters of the site.

Design method:

- Design method according to EN 1992-4 (A).

¹ Note: Particular aggressive conditions are e.g. permanent, alternating immersion in seawater or the splash zone of seawater, chloride atmosphere of indoor swimming pools or atmosphere with extreme chemical pollution (e.g. in desulphurization plants or road tunnels where de-icing materials are used).

Annex B.2: Applicator gun and cleaning brush



Figure B.2.1: Applicator gun.



Figure B.2.2: Cleaning steel brush



Figure B.2.3: Brush extensions.

Annex B.3: Installation procedure

Before commencing installation ensure the operative is equipped with appropriate personal protection equipment, SDS Hammer Drill, Air, Hole Cleaning Brush, good quality Dispensing Tool – either manual or power operated, chemical cartridge with mixing nozzle and extension tube, if needed.

Step 1: Bore hole drilling.



- Drilling of hole with an electric drill to the diameter and depth required by the selected reinforcing bar. Drill hole diameter must be in accordance with anchor size.

Step 2: Bore hole cleaning.



- Start from the bottom or back of the bore hole, blow the hole clean with compressed air (min. 30 seconds) or an air machine a minimum of two times. If the bore hole ground is not reached an extension shall be used.



- Brush the hole with an appropriately sized wide brush a minimum of two times. If the bore hole ground is not reached with the brush, a brush extension shall be used. The diameter of wire brush is equal to the hole diameter.

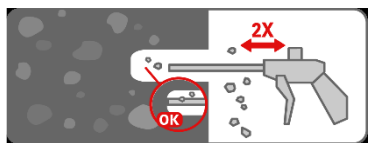

- For bore holes deeper than 200 mm, or bore hole diameter bigger than 35 mm, compressed air (min. 30 seconds) must be used. Finally blow the hole clean again with compressed air (min. 30 seconds) or an air machine a minimum of two times. If the bore hole ground is not reached an extension shall be used.



- When the bonded fastener is installed in wet concrete or in water-filled drill holes the cleaning procedure shall be executed twice.
- In any case, the cleaning procedure will continue until the bore hole is completely cleaned.
- Prior to dispensing into the anchor hole, squeeze out separately the resin until it shows a consistent red color, and discard non-uniformly mixed adhesive components.

Step 3: Bore hole filling.



- Start from the bottom or back of the cleaned anchor hole and fill the hole up to approximately two-thirds with adhesive. Slowly withdraw the static mixing nozzle as the hole fills to avoid creating air pockets.

Step 4: Anchor.

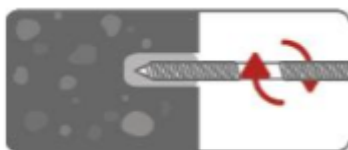

- Insert the anchor with a rotary motion into the filled drill hole. Some adhesive must come out of the hole. The anchor must be placed within the minimum and maximum curing time.

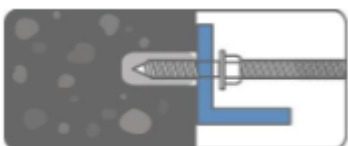

- During the resin hardening time the anchor must not be moved or loaded.

Annex B.4: Installation parameters

The following table includes the installation parameters of the threaded rod.

Size		M8	M10	M12	M16	M20	M24	M27	M30
Nominal drill hole diameter $\varnothing d_0$	[mm]	10	12	14	18	22	28	30	35
Cleaning brush diameter	[mm]	11	14	16	20	25	30	40	40
Maximum installation torque $T_{inst, max}$	[N·m]	10	20	40	80	150	200	270	300
Minimum embedment depth $h_{ef, min}$	[mm]	60	60	70	80	90	96	108	120
Maximum embedment depth $h_{ef, max}$	[mm]	160	200	240	320	400	480	540	600
Minimum edge distance c_{min}	[mm]	40	45	45	50	55	60	75	80
Minimum spacing s_{min}	[mm]	40	50	60	75	90	115	120	140
Minimum thickness of member h_{min}	[mm]	$h_{ef} + 30 (\geq 100)$			$h_{ef} + 2 \cdot d_0$				

Table B.4.1: Installation parameters of threaded rod.

The following table includes the installation parameters of the rebar.

Size		$\varnothing 10$	$\varnothing 12$	$\varnothing 16$	$\varnothing 20$	$\varnothing 25$	$\varnothing 32$
Nominal drill hole diameter $\varnothing d_0$	[mm]	14	16	20	25	30	40
Cleaning brush diameter	[mm]	16	18	22	30	40	45
Maximum installation torque $T_{inst, max}$	[N·m]	20	40	80	150	270	300
Minimum embedment depth $h_{ef, min}$	[mm]	60	70	80	90	100	128
Maximum embedment depth $h_{ef, max}$	[mm]	200	240	320	400	500	640
Minimum edge distance c_{min}	[mm]	45	45	50	65	70	80
Minimum spacing s_{min}	[mm]	50	60	80	100	125	160
Minimum thickness of member h_{min}	[mm]	$h_{ef} + 30 (\geq 100)$			$h_{ef} + 2 \cdot d_0$		

Table B.4.2: Installation parameters of rebar.

Annex B.5: Curing time

Base Material Temperature [°C]	Minimum curing time [min]	Maximum curing time [h]
+10°C to + 15°C	600 (10 h)	48
+15°C to + 20°C	150	30
+20°C to + 25°C	60	24
+25°C to + 30°C	30	15
+30°C to + 35°C	15	10
+35°C to + 40°C	8	6

Table B.5.1: Curing time in dry concrete.

Base Material Temperature [°C]	Minimum curing time [min]	Maximum curing time [h]
+10°C to + 15°C	720 (12 h)	72
+15°C to + 20°C	180	45
+20°C to + 25°C	80	36
+25°C to + 30°C	40	20
+30°C to + 35°C	20	12
+35°C to + 40°C	11	8

Table B.5.2: Curing time in wet concrete.

Annex C: Performances

Annex C.1: Characteristic resistance to tension load of threaded rod

Resistance to steel failure for tension load										
Size			M8	M10	M12	M16	M20	M24	M27	M30
Steel grade 4.6	$N_{Rk,s}$	[kN]	15	23	34	63	98	141	184	224
Partial safety factor	$\gamma_{Ms}^{(2)}$	[-]	2,00							
Steel grade 5.8	$N_{Rk,s}$	[kN]	18	29	42	79	123	177	230	281
Partial safety factor	$\gamma_{Ms}^{(2)}$	[-]	1,50							
Steel grade 8.8	$N_{Rk,s}$	[kN]	29	46	67	126	196	282	367	449
Partial safety factor	$\gamma_{Ms}^{(2)}$	[-]	1,50							
Steel grade 10.9	$N_{Rk,s}$	[kN]	37	58	84	157	245	353	459	561
Partial safety factor	$\gamma_{Ms}^{(2)}$	[-]	1,33							
Steel grade A2-70, A4-70	$N_{Rk,s}$	[kN]	26	41	59	110	172	247	321	393
Partial safety factor	$\gamma_{Ms}^{(2)}$	[-]	1,87							
Steel grade A4-80	$N_{Rk,s}$	[kN]	29	46	67	126	196	282	367	449
Partial safety factor	$\gamma_{Ms}^{(2)}$	[-]	1,60							
Steel grade 1.4529	$N_{Rk,s}$	[kN]	26	41	59	110	172	247	321	393
Partial safety factor	$\gamma_{Ms}^{(2)}$	[-]	1,50							
Steel grade 1.4565	$N_{Rk,s}$	[kN]	26	41	59	110	172	247	321	393
Partial safety factor	$\gamma_{Ms}^{(2)}$	[-]	1,87							

Table C.1.1: Resistance to steel failure for tension load.

Resistance to combined pull-out and concrete failure										
Characteristic bond resistance in non-cracked concrete C20/25										
Size			M8	M10	M12	M16	M20	M24	M27	M30
Temperature A: -40 °C to +40 °C	T_{Rk}	[N/mm ²]	13,0 [*]	13,0	12,0	10,5	10,0	10,0	9,0	9,0
Factor for sustained load for long-term temperature at +40 °C	ψ_{sus}^0	[-]	1,0							
Factor for concrete C50/60	ψ_c	[-]	1,10							

* M8 size failure mode is always steel failure, when used according to manufacturer's installation parameters (see table C.1.1).

Table C.1.2: Resistance to combined pull-out and concrete failure.

² In absence of national regulations.

Resistance to concrete cone failure for tension load

Size	M8	M10	M12	M16	M20	M24	M27	M30
Factor according to EAD 330499-01-0601, clause 2.2.3.1	$k_{ucr,N}$				11			
	$k_{cr,N}$				7,7			
	$C_{cr,N}$				$1,5 \cdot h_{ef}$			

Table C.1.3: Resistance to concrete cone failure for tension load.**Edge distance to prevent splitting under load**

Size	M8	M10	M12	M16	M20	M24	M27	M30
Edge distance	$C_{cr,sp}$	[mm]		$2 \cdot C_{min}$				
Spacing	$S_{cr,sp}$	[mm]		$2 \cdot C_{cr,sp}$				

Table C.1.4: Edge distance to prevent splitting under load.**Robustness**

Size	M8	M10	M12	M16	M20	M24	M27	M30
Factor accounting for the sensitivity of installation	$\gamma_{inst}^{3)}$	[-]		1,4				

Table C.1.5: Robustness.**Maximum installation torque**

Size	M8	M10	M12	M16	M20	M24	M27	M30		
Maximum installation torque	$\max T_{inst}$	[N·m]	10	20	40	80	150	200	270	300

Table C.1.6: Maximum installation torque.**Minimum edge distance and spacing**

Size	M8	M10	M12	M16	M20	M24	M27	M30			
Edge distance	C_{min}	[mm]		40	45	45	50	55	60	75	80
Spacing	S_{min}	[mm]		40	50	60	75	90	115	120	140
Minimum thickness of concrete member	h_{min}	[mm]		$h_{ef} + 30 (\geq 100)$			$h_{ef} + 2 \cdot d_o$				

Table C.1.7: Minimum edge distance and spacing.³ The partial safety factor $\gamma_2 = 1,0$ is included.

Annex C.2: Characteristic resistance to tension load of rebar

Resistance to steel failure for tension load								
Size			Ø10	Ø12	Ø16	Ø20	Ø25	Ø32
Rebar BSt 500 S	$N_{Rk,s}$	[kN]	43	62	111	173	270	442
Partial safety factor	$\gamma_{Ms}^{(2)}$	[-]	1,4					

Table C.2.1: Resistance to steel failure for tension load.

Resistance to combined pull-out and concrete failure								
Characteristic bond resistance in non-cracked concrete C20/25								
Size			Ø10	Ø12	Ø16	Ø20	Ø25	Ø32
Temperature A: -40 °C to +40 °C	T_{Rk}	[N/mm ²]	11,0	11,0	10,5	9,5	9,0	9,0
Factor for sustained load for long-term temperature at +40 °C	ψ_{sus}^0	[-]	1,0					
Factor for concrete C50/60	ψ_c	[-]	1,10					

Table C.2.2: Resistance to combined pull-out and concrete failure.

Resistance to concrete cone failure for tension load								
Size			Ø10	Ø12	Ø16	Ø20	Ø25	Ø32
Factor according to EAD 330499-01-0601, clause 2.2.3.1	$K_{ucr,N}$		11					
	$k_{cr,N}$		7,7					
	$C_{cr,N}$		$1,5 \cdot h_{ef}$					

Table C.2.3: Resistance to concrete cone failure for tension load.

Edge distance to prevent splitting under load								
Size			Ø10	Ø12	Ø16	Ø20	Ø25	Ø32
Edge distance	$C_{cr,sp}$	[mm]	$2 \cdot C_{min}$					
Spacing	$S_{cr,sp}$	[mm]	$2 \cdot C_{cr,sp}$					

Table C.2.4: Edge distance to prevent splitting under load.

Robustness

Size			Ø10	Ø12	Ø16	Ø20	Ø25	Ø32
Factor accounting for the sensitivity of installation	$\gamma_{inst}^{3)}$	[-]				1,4		

Table C.2.5: Robustness.**Maximum installation torque**

Size			Ø10	Ø12	Ø16	Ø20	Ø25	Ø32
Maximum installation torque	$\max T_{inst}$	[N·m]	20	40	80	150	270	300

Table C.2.6: Maximum installation torque.**Minimum edge distance and spacing**

Size			Ø10	Ø12	Ø16	Ø20	Ø25	Ø32
Edge distance	c_{min}	[mm]	45	45	50	65	70	80
Spacing	s_{min}	[mm]	50	60	80	100	125	160
Minimum thickness of concrete member	h_{min}	[mm]	$h_{ef} + 30 (\geq 100)$			$h_{ef} + 2 \cdot d_0$		

Table C.2.7: Minimum edge distance and spacing.

Annex C.3: Characteristic resistance to shear load of threaded rod

Resistance to steel failure for shear load										
Size			M8	M10	M12	M16	M20	M24	M27	M30
Steel grade 4.6	$V_{Rk,s}$	[kN]	7	12	17	31	49	71	92	112
Partial safety factor	$\gamma_{Ms^{(2)}}$	[-]	1,67							
Steel grade 5.8	$V_{Rk,s}$	[kN]	9	15	21	39	61	88	115	140
Partial safety factor	$\gamma_{Ms^{(2)}}$	[-]	1,25							
Steel grade 8.8	$V_{Rk,s}$	[kN]	15	23	34	63	98	141	184	224
Partial safety factor	$\gamma_{Ms^{(2)}}$	[-]	1,25							
Steel grade 10.9	$V_{Rk,s}$	[kN]	18	29	42	79	123	177	230	281
Partial safety factor	$\gamma_{Ms^{(2)}}$	[-]	1,5							
Steel grade A2-70, A4-70	$V_{Rk,s}$	[kN]	13	20	30	55	86	124	161	196
Partial safety factor	$\gamma_{Ms^{(2)}}$	[-]	1,56							
Steel grade A4-80	$V_{Rk,s}$	[kN]	15	23	34	63	98	141	184	224
Partial safety factor	$\gamma_{Ms^{(2)}}$	[-]	1,33							
Steel grade 1.4529	$V_{Rk,s}$	[kN]	13	20	30	55	86	124	161	196
Partial safety factor	$\gamma_{Ms^{(2)}}$	[-]	1,25							
Steel grade 1.4565	$V_{Rk,s}$	[kN]	13	20	30	55	86	124	161	196
Partial safety factor	$\gamma_{Ms^{(2)}}$	[-]	1,56							
Ductility factor according to EAD 330499-01-0601, clause 2.2.7.2	k_7	[-]	0,8 for steel characterised by a rupture elongation $A_5 \leq 8 \%$ 1,0 for steel characterised by a rupture elongation $A_5 > 8 \%$							

Table C.3.1: Resistance to steel failure for shear load.

Resistance to steel failure for shear load with lever arm										
Size			M8	M10	M12	M16	M20	M24	M27	M30
Steel grade 4.6	$M_{Rk,s}$	[N·m]	15	30	52	133	260	449	666	900
Partial safety factor	$\gamma_{Ms}^{(2)}$	[-]	1,67							
Steel grade 5.8	$M_{Rk,s}$	[N·m]	19	37	66	166	325	561	832	1125
Partial safety factor	$\gamma_{Ms}^{(2)}$	[-]	1,25							
Steel grade 8.8	$M_{Rk,s}$	[N·m]	30	60	105	266	519	898	1332	1799
Partial safety factor	$\gamma_{Ms}^{(2)}$	[-]	1,25							
Steel grade 10.9	$M_{Rk,s}$	[N·m]	37	75	131	333	649	1123	1664	2249
Partial safety factor	$\gamma_{Ms}^{(2)}$	[-]	1,5							
Steel grade A2-70, A4-70	$M_{Rk,s}$	[N·m]	26	52	92	233	454	786	1165	1574
Partial safety factor	$\gamma_{Ms}^{(2)}$	[-]	1,56							
Steel grade A4-80	$M_{Rk,s}$	[N·m]	30	60	105	266	519	898	1332	1799
Partial safety factor	$\gamma_{Ms}^{(2)}$	[-]	1,33							
Steel grade 1.4529	$M_{Rk,s}$	[N·m]	26	52	92	233	454	786	1165	1574
Partial safety factor	$\gamma_{Ms}^{(2)}$	[-]	1,25							
Steel grade 1.4565	$M_{Rk,s}$	[N·m]	26	52	92	233	454	786	1165	1574
Partial safety factor	$\gamma_{Ms}^{(2)}$	[-]	1,56							
Ductility factor according to EAD 330499-01-0601, clause 2.2.7.2	k_7	[-]	0,8 for steel characterised by a rupture elongation $A_5 \leq 8\%$ 1,0 for steel characterised by a rupture elongation $A_5 > 8\%$							

Table C.3.2: Resistance to steel failure for shear load with lever arm.

Resistance to pry-out										
Size			M8	M10	M12	M16	M20	M24	M27	M30
Factor for calculation of characteristic resistance to pry-out failure	k_7	[-]	2,0							

Table C.3.3: Resistance to pry-out.

Resistance to concrete edge failure for shear load										
Size			M8	M10	M12	M16	M20	M24	M27	M30
Outside diameter of anchor	d_{nom}	[mm]	8	10	12	16	20	24	27	30
Effective length of anchor	l_f	[mm]	for $d_{nom} \leq 24$ mm: $\min(h_{ef}; 12 \cdot d_{nom})$ for $d_{nom} > 24$ mm: $\min(h_{ef}; 8 \cdot d_{nom}; 300$ mm)							

Table C.3.4: Resistance to concrete edge failure for shear load.

Annex C.4: Characteristic resistance to shear load of rebar

Resistance to steel failure for shear load									
Size			Ø10	Ø12	Ø16	Ø20	Ø25	Ø32	
Rebar BSt 500 S	$V_{Rk,s}$	[kN]	22	31	55	86	135	221	
Partial safety factor	$\gamma_{Ms}^{(2)}$	[-]	1,5						
Ductility factor according to EAD 330499-01-0601, clause 2.2.7.2	k_7	[-]	0,8 for steel characterised by a rupture elongation $A_5 \leq 8\%$ 1,0 for steel characterised by a rupture elongation $A_5 > 8\%$						

Table C.4.1: Resistance to steel failure for shear load.

Resistance to steel failure for shear load with lever arm									
Size			Ø10	Ø12	Ø16	Ø20	Ø25	Ø32	
Rebar BSt 500 S	$M_{Rk,s}$	[kN]	65	112	265	518	1.013	2.122	
Partial safety factor	$\gamma_{Ms}^{(2)}$	[-]	1,5						
Ductility factor according to EAD 330499-01-0601, clause 2.2.7.2	k_7	[-]	0,8 for steel characterised by a rupture elongation $A_5 \leq 8\%$ 1,0 for steel characterised by a rupture elongation $A_5 > 8\%$						

Table C.4.2: Resistance to steel failure for shear load with lever arm.

Resistance to pry-out									
Size			Ø10	Ø12	Ø16	Ø20	Ø25	Ø32	
Factor for calculation of characteristic resistance to pry-out failure	k_7	[-]	2,0						

Table C.4.3: Resistance to pry-out.

Resistance to concrete edge failure for shear load									
Size			Ø10	Ø12	Ø16	Ø20	Ø25	Ø32	
Outside diameter of anchor	d_{nom}	[mm]	10	12	16	20	25	32	
Effective length of anchor	l_f	[mm]	for $d_{nom} \leq 24$ mm: $\min(h_{ef}; 12 \cdot d_{nom})$ for $d_{nom} > 24$ mm: $\min(h_{ef}; 8 \cdot d_{nom}; 300$ mm)						

Table C.4.4: Resistance to concrete edge failure for shear load.

Annex C.5: Displacements for threaded rod

Displacement of threaded rod under tension and shear load									
Size		M8	M10	M12	M16	M20	M24	M27	M30
Tension load									
δ_{N0}	[mm/kN]	0,020	0,020	0,014	0,012	0,007	0,008	0,004	0,005
$\delta_{N\infty}$	[mm/kN]	0,076	0,063	0,047	0,038	0,025	0,023	0,020	0,017
Shear load									
δ_{V0}	[mm/kN]	0,470	0,301	0,209	0,118	0,075	0,050	0,035	0,031
$\delta_{V\infty}$	[mm/kN]	0,705	0,451	0,314	0,177	0,113	0,075	0,052	0,047

Table C.5.1: Displacement of threaded rod under tension and shear load.

Annex C.6: Displacements for rebar

Displacement of rebar under tension and shear load						
Size	Ø10	Ø12	Ø16	Ø20	Ø25	Ø32
Tension load of the non-cracked concrete						
δ_{N0} [mm/kN]	0,047	0,032	0,021	0,013	0,014	0,010
$\delta_{N\infty}$ [mm/kN]	0,063	0,047	0,038	0,025	0,022	0,015
Shear load						
δ_{V0} [mm/kN]	0,291	0,200	0,118	0,075	0,050	0,031
$\delta_{V\infty}$ [mm/kN]	0,431	0,304	0,177	0,113	0,075	0,047

Table C.6.1: Displacement of rebar under tension and shear load.