



**Institut de  
Tecnologia de la Construcció  
de Catalunya**

Wellington 19  
ES08018 Barcelona  
T +34 933 09 34 04  
qualprod@itec.cat  
itec.cat



Member of



www.eota.eu

# European Technical Assessment

**ETA 16/0827**  
of 18.04.2017



## General part

<b>Technical Assessment Body issuing the ETA: ITeC</b>	
ITeC has been designated according to Article 29 of Regulation (EU) No 305/2011 and is member of EOTA (European Organisation for Technical Assessment)	
<b>Trade name of the construction product</b>	<b>SEH<sup>®</sup> Constructive System</b>
<b>Product family to which the construction product belongs</b>	34 – Building kits, units, and prefabricated elements
<b>Manufacturer</b>	<b>Sustainable Energy &amp; Housing SL</b> C/ Larrauri, 1 bajo ES-48180 Loiu (Bizkaia) Spain
<b>Manufacturing plant(s)</b>	According to Annex N kept by ITeC
<b>This European Technical Assessment contains</b>	14 pages including 3 annexes and an Annex N, which contains confidential information and is not included in the European Technical Assessment when that assessment is publicly available.
<b>This European Technical Assessment is issued in accordance with Regulation (EU) 305/2011, on the basis of</b>	ETAG 023 <i>Prefabricated building units</i> , edition August 2006, used as European Assessment Document (EAD)

### **General comments**

Translations of this European Technical Assessment in other languages shall fully correspond to the original issued document and should be identified as such.

Communication of this European Technical Assessment, including transmission by electronic means, shall be in full (excepted the confidential Annex referred to above). However, partial reproduction may be made, with the written consent of issuing Technical Assessment Body. Any partial reproduction has to be identified as such.

## **Specific parts of the European Technical Assessment**

### **1 Technical description of the product**

SEH<sup>®</sup> Constructive System are prefabricated three-dimensional, transportable and relocatable load-bearing structures of building units consisting of welded frames made of hot rolled steel profiles, steel connection-pieces and other components required for structural stability.

Detailed information and data of the steel frame building units and all the components are given in the Annex 1 of this ETA.

The building units form the load-bearing structure of a complete building as an individual unit or in conjunction with other units.

All building elements not specified in this ETA (e.g. flooring, non-loadbearing walls, ceilings, substructures, foundations, external and internal claddings, roof coverings, windows, doors, stairs, surface coverings, service installations, etc.) which are required for a complete building do not form part of the building units assessed in this ETA.

The complete buildings (the works) based on the structural units given in this ETA are not under the responsibility of the manufacturer Sustainable Energy & Housing SL. The way to ensure that the final building meets the local regulatory requirements shall be provided at national level. The person(s) responsible for the fulfilment of the essential requirements of the complete building can contact Sustainable Energy & Housing SL for all necessary data and details.

### **2 Specification of the intended use(s) in accordance with the applicable European Assessment Document (hereinafter EAD)**

SEH<sup>®</sup> Constructive System is intended to be used as load-bearing structure units of one to five-storey buildings.

The building units may be grouped parallelly or perpendicularly to form the shape of the building base provided that the columns of the units coincide with each other (see Figures A2.1 in Annex 2).

The buildings composed by SEH<sup>®</sup> Constructive System may be used in seismic zones.

General information and data regarding manufacture, design, installation, transport, maintenance and repair criteria are given in Annex 3.

The provisions made in this European Technical Assessment are based on an assumed working life of at least 50 years for the load-bearing structure provided that conditions given by Sustainable Energy & Housing SL for transport, storage, installation, maintenance and repair are met (see Annex 3). The indications given on the working life cannot be interpreted as a guarantee given by the producer, but are to be regarded only as a means for choosing the right products in relation to the expected economically reasonable working life of the works.

### **3 Performance of the product and reference to the methods used for its assessment**

The assessment of SEH<sup>®</sup> Constructive System for the intended use was performed following ETAG 023 *Prefabricated building units*, used as EAD.

**Table 3.1:** SEH<sup>®</sup> Constructive System performances (see also detailed performances in relevant sections).

<b>Product:</b> SEH <sup>®</sup> Constructive System		<b>Intended use:</b> Load-bearing structure of buildings	
<b>Basic Works Requirement</b>	<b>ETA section</b>	<b>Essential characteristic</b>	<b>Performance</b>
BWR 1 Mechanical resistance and stability	3.1	Mechanical resistance and stability	See section 3.1
BWR 2 Safety in case of fire	3.2 3.3	Reaction to fire Resistance to fire	A1 See section 3.3
BWR 3 Hygiene, health and the environment	---	Content and/or release of dangerous substances	Not assessed
Durability aspects	3.4	Corrosion protection	See section 3.4
	3.5	Serviceability	See section 3.5

### 3.1 Mechanical resistance and stability

Mechanical resistance and stability is assessed by means of the geometrical data of the units and components and the mechanical properties of the materials of the components (see Annex 1).

The structural design of the buildings composed by the SEH<sup>®</sup> Constructive System structural units, including relevant connections, should be undertaken by calculation respecting the design load-bearing capacity of the components and connection-pieces at the Ultimate State Limit (collapse) and the Serviceability Limit State (deflection) according to relevant Eurocodes (e.g. EN 1990, EN 1991-1-1, EN 1993, etc.) and National Provisions.

Design approach I (see figure 2 of ETAG 023) and unit types A, B, C and D1 (see figure 1 of ETAG 023) should be considered.

Regarding seismic performances, low capacity to dissipate energy is recommended: DCL ductility class and energy dissipation factor  $q = 1,5$ .

Examples of load-bearing capacity of some structural building shapes have been calculated and they are given in section A2.2 of Annex 2. These examples should neither be considered as the only design option nor as presuppose types.

All the technical documentation of this ETA is deposited in the Catalonia Institute of Construction Technology (ITeC) in so far as relevant for the body involved in the tasks of AVCP.

### 3.2 Reaction to fire

Reaction to fire of SEH<sup>®</sup> Constructive System components, according to the Commission Delegated Regulation (EU) 2016/364 and EN 13501-1, is class A1 (without need of testing according to Decision 96/603/EC as amended).

### 3.3 Resistance to fire

The load-bearing capacity of the buildings, composed by the building units including relevant connections, when exposed to fire, should be calculated, according to relevant Eurocodes (e.g. EN 1993-1-2) and National Provisions, considering the geometrical data and mechanical properties of the unit components given in Annex 1 and relevant fire protection, if needed.

### 3.4 Corrosion protection

The material and corrosion protection of SEH<sup>®</sup> Constructive System components are defined in the relevant sections of Annex 1.

EN ISO 12944-1 to -8 and EN 1090-2 should be taken into account for the corrosion protection of steel components.

### 3.5 Serviceability

Values of maximum deflection at serviceability limit state are:

- $H/300$  for horizontal deflection with  $H$  equal to the unit height
- $L/300$  for vertical deflection with  $L$  equal to the maximum floor span.

## 4 Assessment and verification of constancy of performance (hereinafter AVCP) system applied, with reference to its legal base

According to the decision 2003/728/EC, as amended of the European Commission<sup>1</sup>, the systems of AVCP (see EC delegated regulation (EU) No 568/2014 amending Annex V to Regulation (EU) 305/2011) given in the following table apply.

**Table 4.1:** Applicable AVPC system.

Product	Intended use	Level or class	System
Prefabricated Building Units	In Building Works	Any	1

## 5 Technical details necessary for the implementation of the AVCP system, as foreseen in the applicable EAD

All the necessary technical details for the implementation of the AVCP system are laid down in the *Control Plan* deposited with the ITeC<sup>2</sup>, with which the factory production control shall be in accordance.

Issued in Barcelona on 18 April 2017

by the Catalonia Institute of Construction Technology.



Ferran Bermejo Nualart  
 Technical Director, ITeC

<sup>1</sup> 2003/728/EC – Commission Decision published in the Official Journal of the European Union (OJEU) L262/34 of 14/10/2003.

<sup>2</sup> The *Control Plan* is a confidential part of the ETA and is only handed over to the notified certification body involved in the assessment and verification of constancy of performance.

## ANNEX 1: Product description

### A1.1 General

SEH<sup>®</sup> Constructive System are prefabricated three-dimensional, transportable and relocatable load-bearing structures of building units.

Each unit SEH<sup>®</sup> is composed of steel profiles (columns, floor/ceiling main beams and floor/ceiling secondary beams) connected between them by welding.

All the building units are based on the dimensions and shape of the basic units given in section A1.2. In all cases 6 or 4 columns and floor/ceiling main beams (boundary beams) are necessary. However, the grid design of the floor/ceiling secondary beams can be different depending on the complete building needs (e.g. to enable stairs and elevators to pass through them).

Steel connection-pieces are used between the units and the foundations or between two contiguous units.

Additionally, other components required for structural stability such as cross-braces may be used.

Figure A1.1 shows the components of the units and connection-pieces.

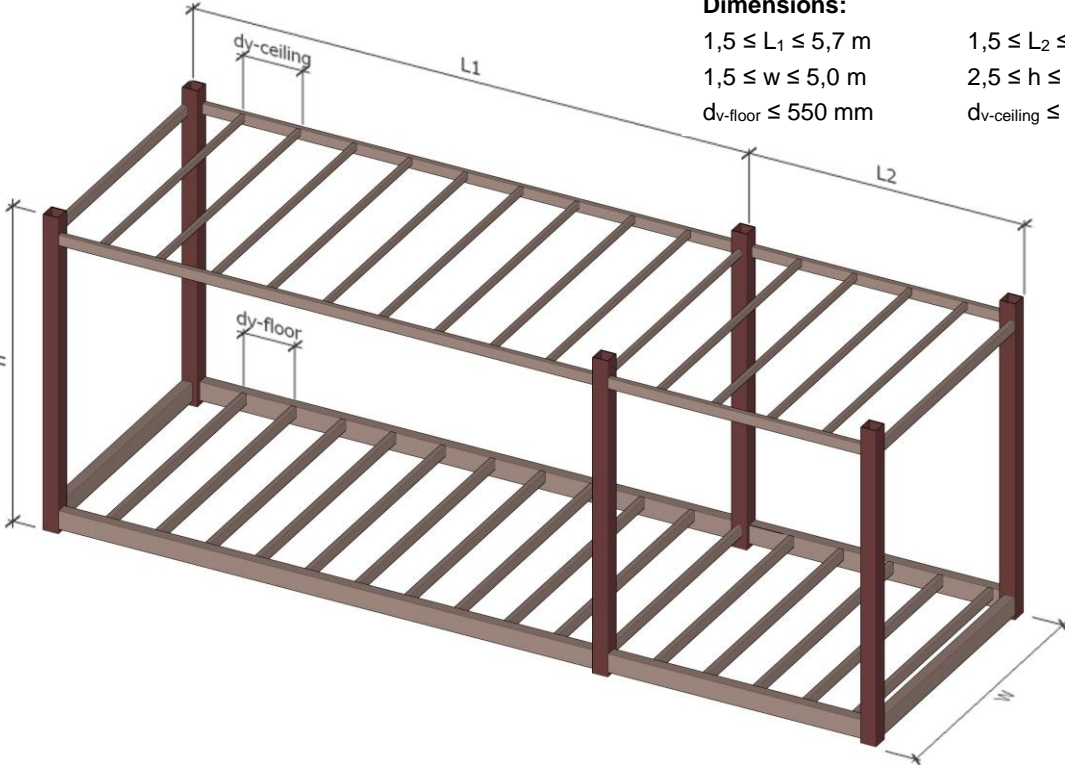
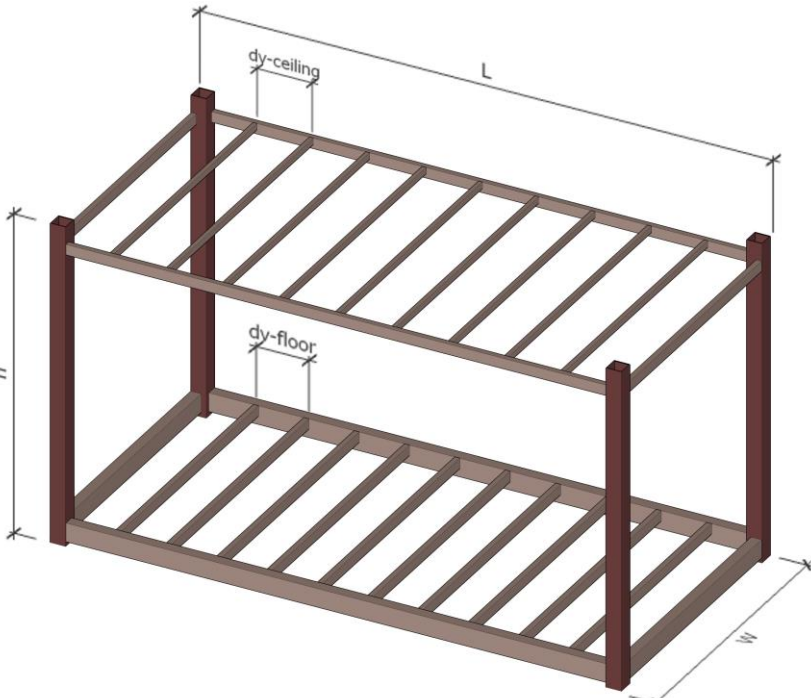

Figure A1.1: SEH<sup>®</sup> units, components and connection-pieces.

## A1.2 Basic units

There are two basic units for the SEH<sup>®</sup> Constructive System depending on whether the unit has four or six columns. The shape and dimensions of the basic units is shown in table A1.1.

**Table A1.1:** Shape and dimensions of the SEH<sup>®</sup> basic units.

<p><b>Unit of 6 columns</b></p> 	<p><b>Dimensions:</b></p> <table border="0"> <tbody> <tr> <td><math>1,5 \leq L_1 \leq 5,7 \text{ m}</math></td> <td><math>1,5 \leq L_2 \leq 5,7 \text{ m}</math></td> </tr> <tr> <td><math>1,5 \leq w \leq 5,0 \text{ m}</math></td> <td><math>2,5 \leq h \leq 3,2 \text{ m}</math></td> </tr> <tr> <td><math>d_{v\text{-floor}} \leq 550 \text{ mm}</math></td> <td><math>d_{v\text{-ceiling}} \leq 610 \text{ mm}</math></td> </tr> </tbody> </table>	$1,5 \leq L_1 \leq 5,7 \text{ m}$	$1,5 \leq L_2 \leq 5,7 \text{ m}$	$1,5 \leq w \leq 5,0 \text{ m}$	$2,5 \leq h \leq 3,2 \text{ m}$	$d_{v\text{-floor}} \leq 550 \text{ mm}$	$d_{v\text{-ceiling}} \leq 610 \text{ mm}$
$1,5 \leq L_1 \leq 5,7 \text{ m}$	$1,5 \leq L_2 \leq 5,7 \text{ m}$						
$1,5 \leq w \leq 5,0 \text{ m}$	$2,5 \leq h \leq 3,2 \text{ m}$						
$d_{v\text{-floor}} \leq 550 \text{ mm}$	$d_{v\text{-ceiling}} \leq 610 \text{ mm}$						
<p><b>Unit of 4 columns</b></p> 	<p><b>Dimensions:</b></p> <table border="0"> <tbody> <tr> <td><math>1,5 \leq L \leq 5,7 \text{ m}</math></td> </tr> <tr> <td><math>1,5 \leq w \leq 5,0 \text{ m}</math></td> </tr> <tr> <td><math>2,5 \leq h \leq 3,2 \text{ m}</math></td> </tr> <tr> <td><math>d_{v\text{-floor}} \leq 550 \text{ mm}</math></td> </tr> <tr> <td><math>d_{v\text{-ceiling}} \leq 610 \text{ mm}</math></td> </tr> </tbody> </table>	$1,5 \leq L \leq 5,7 \text{ m}$	$1,5 \leq w \leq 5,0 \text{ m}$	$2,5 \leq h \leq 3,2 \text{ m}$	$d_{v\text{-floor}} \leq 550 \text{ mm}$	$d_{v\text{-ceiling}} \leq 610 \text{ mm}$	
$1,5 \leq L \leq 5,7 \text{ m}$							
$1,5 \leq w \leq 5,0 \text{ m}$							
$2,5 \leq h \leq 3,2 \text{ m}$							
$d_{v\text{-floor}} \leq 550 \text{ mm}$							
$d_{v\text{-ceiling}} \leq 610 \text{ mm}$							

### A1.3 Types of connection-pieces

SEH<sup>®</sup> Constructive System considers eight types of connection-pieces depending on the following criteria:

- The number of columns to be connected.
- The position between units.

Shape of each connection-piece is shown in table A1.2.

Steel columns and plates of the connection-pieces are connected between them by welding.

**Table A1.2:** SEH<sup>®</sup> connection-piece types.

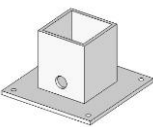
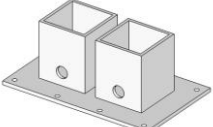
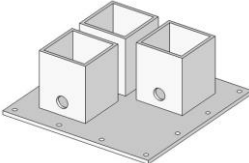
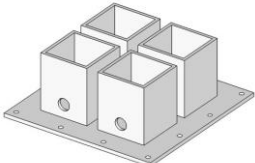
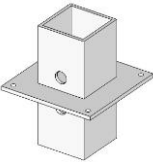
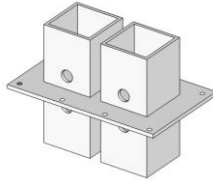
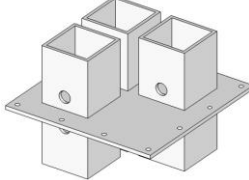
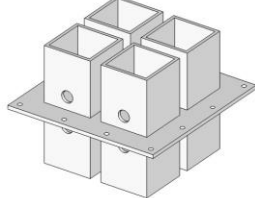
Connection position	Number of columns to be connected			
	1-column	2-columns	3-columns	4-columns
<b>Extreme</b> (connection between the units and the foundation or roof covering)				
<b>Intermediate</b> (connection between units in different floors)				

### A1.4 Components list. Dimensions and materials

Components, minimum dimensions and materials of the SEH<sup>®</sup> units and the connection-pieces are specified in table A1.3.

**Table A1.3:** SEH<sup>®</sup> Constructive System components, geometries and materials.

Element	Component	Type	Minimum dimensions (mm)	Material	References
	Columns	Square Hollow Section (SHS) profile	SHS 150 x 150 x 5		
	Floor main beams		RHS 180 x 100 x 4		
SEH <sup>®</sup> unit	Ceiling main beams	Rectangular Hollow Section (RHS) profile	RHS 100 x 50 x 5	Table A1.4	EN 10025-2 EN 10210-2
	Floor secondary beams		RHS 100 x 50 x 3		
	Ceiling secondary beams		RHS 60 x 40 x 3		

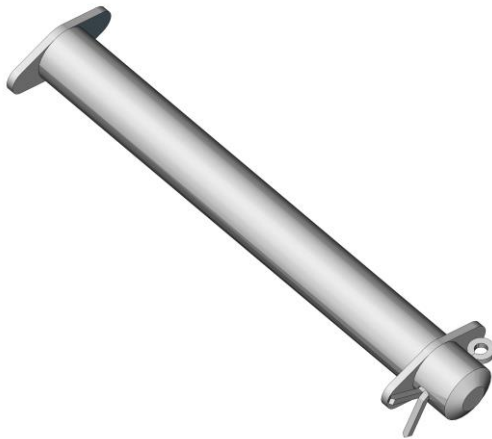

**Table A1.3:** SEH<sup>®</sup> Constructive System components, geometries and materials.

Element	Component	Type	Minimum dimensions (mm)	Material	References
Connection -piece	Column	Square Hollow Section (SHS) profile	SHS 130 x 130 x 8 Length: 150	Table A1.4	EN 10025-2 EN 10210-2
	One-column plate	Flat plate	250 x 250 x 10		
	Two-columns plate		250 x 410 x 10		
	Three-columns plate		410 x 410 x 10		
	Four-columns plate				
	Fixings between connection-pieces and the unit columns Figure A1.2a	Bolt	Figure A1.2b	Table A1.4	EN 10277-2
		Washer			
		Split pin	Nominal diameter: 8 Nominal length: 71 Figure A1.2c	Low carbon steel DC01 (1.0330)	EN ISO 1234 EN 10139

**Table A1.4:** Mechanical properties of the steel components.

Steel type	Characteristic	Value		Reference	
Non-alloy structural steel	Designation	S275JR (1.0044)	S355JR (1.0045)	EN 10025-2 EN 1993-1-1	
	Elastic limit R <sub>e</sub> (MPa)	≥ 275	≥ 355		
	Elongation A <sub>80</sub> (%)	≥ 23			
	Tensile strength R <sub>m</sub> (MPa)	430 to 580	510 to 630		
	Modulus of elasticity at 20 °C (MPa)	210000			
	Poisson coefficient	0,3			
	Thermal expansion coefficient between 20 °C and 100 °C (µm/m·°C)	12,0			
	Corrosion protection	Protective paint systems			EN ISO 12944-1 to -8 EN 1090-2



**Figure A1.2a:** Fixings between connection-piece and the unit columns.

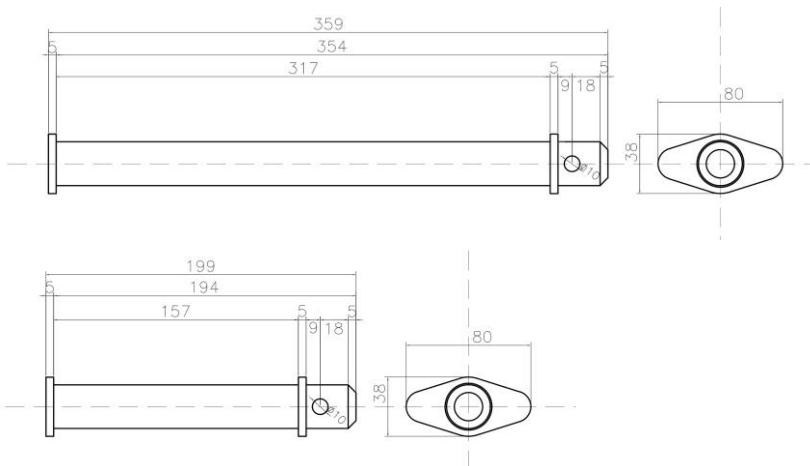

**Figure A1.2b:** Bolts and washers for the fixing of the connection-pieces.

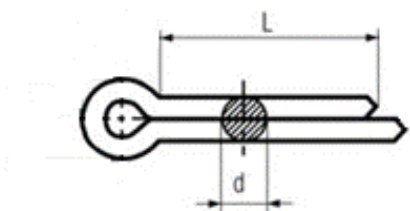

**Figure A1.2c:** Split pin for the fixing of the connection-pieces.

## ANNEX 2: Building shapes

### A2.1 Building base shapes

The building units may be grouped parallelly or perpendicularly to form the shape of the building base provided that the columns of the units coincide with each other. Figures A2.1 show some examples.

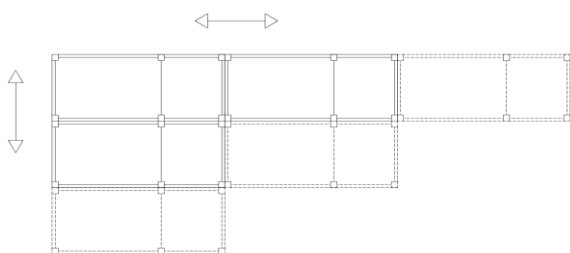

Figure A2.1a: Parallel building base shape.

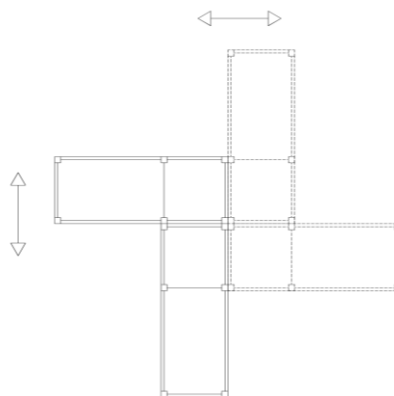

Figure A2.1b: Perpendicular building base shape.

### A2.2 Examples of building shapes

The building shapes given in table A2.2 have been calculated by a qualified technician designated by the manufacturer, taking into account the relevant Eurocodes (EN 1990, EN 1991, EN 1993, EN 1998).

These examples should neither be considered as the only design option nor as presuppose types.

The load hypothesis considered in the examples are given in table A2.1.



The data of the structural units considered in the examples are:

- minimum dimensions of the components (see table A1.3)
- weakest component material (see table A1.4)
- unit size (see table A1.1):  $L_1 = 5,50$  m;  $L_2 = 2,75$  m;  $w = 2,75$  m;  $h = 3,12$  m

Table A2.1: Basic design data used in the calculated examples.

Maximum self-weight of non-structural elements (kN/m <sup>2</sup> )	Floors: 2,00 Ceilings: 0,25 Roofs: 0,60 External walls: 0,30	
Maximum imposed floor load (kN/m <sup>2</sup> )	2,00	
Maximum imposed roof snow load (kN/m <sup>2</sup> )	1,00	
Maximum wind pressure load (kN/m <sup>2</sup> ) (values for the building example 6x5, i.e. 5-storey)	0,88 (on vertical elements) 0,22 (on roof elements)	
Maximum wind suction load (kN/m <sup>2</sup> ) (values for the building example 6x5, i.e. 5-storey)	1,32 (on vertical elements) 1,97 (on roof elements)	
Maximum load to foundation at each column (kN) (values for the building example 6x5, i.e. 5-storey)	415	
Maximum number of storey heights supported	5	
Seismic performance (low seismicity recommended)	Energy dissipation factor q	1,5
	Ductility class	DCL

**Table A2.2:** Examples of building shapes (\*).

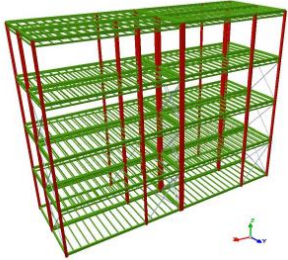
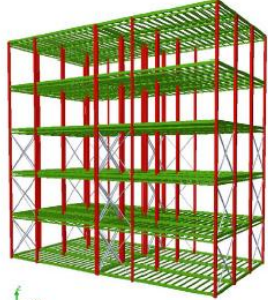
<p>Individual basic unit (1x1) _ 1-storey</p>		<p>One unit in two floors (1x2) _ 2-storey</p>	
<p>Two units in three floors (2x3) _ 3-storey</p>		<p>Four units in four floors (4x4) _ 4-storey</p>	
<p>Six units in five floors (6x5) _ 5-storey</p>		<p>--</p>	
<p>(*) These examples should neither be considered as the only design option nor as presuppose types.</p>			

## **ANNEX 3: Manufacturing, design, installation, transport, maintenance and repair criteria**

### **A3.1 Manufacturing**

The European Technical Assessment is issued for the product based on agreed data/information, deposited with the Catalonia Institute of Construction Technology-ITeC, which identifies the product that has been assessed. Changes to the product or production process, which could result in this deposited data/information being incorrect, should be notified to the Catalonia Institute of Construction Technology-ITeC before the changes are introduced. The Catalonia Institute of Construction Technology (ITeC) will decide whether such changes affect the ETA and consequently the validity of the CE marking based on the ETA and, if so, whether further assessment or alternations to the ETA shall be necessary.

### **A3.2 Design of the buildings**

#### **A3.2.1 Local building regulations**

A specification of relevant requirements concerning structural design, fire resistance and reaction to fire, sound insulation performance, thermal insulation performance and ventilation provisions shall be elaborated for each delivery as a basis for the production and dimensioning of the SEH® Constructive System.

The verifications shall comply with the procedures and requirements including the verification of stability foreseen in the Member States in which the building is to be built. A European Technical Assessment for a prefabricated building unit does not amend this process in any way.

#### **A3.2.2 Design**

Each prefabricated building system is designed in accordance with the requirements of this technical assessment and the requirements and provisions applicable in the Member States where the building is to be erected. A European Technical Assessment for prefabricated building units does not amend this process in any way.

For each prefabricated building system or building project, the mechanical resistance and stability for each individual load-bearing building component and their connections to among each other are determined in accordance with EN 1990 and the relevant applicable parts of EN 1993 taking account of EN 1991 as well as the provisions of the European Technical Assessment and the requirements and provisions applicable in each Member State.

The dimensions and material properties which are indicated in this European Technical Assessment are observed.

The verification of the structural resistance and stability is carried out by a structural engineer experienced in the field of steel structures.

#### **A3.2.3 Substructure**

This European Technical Assessment does not include the substructure, the foundation of a building and the anchorages to substructure or foundation.

With regard to the admissible tolerances the requirements and provisions applicable in the Member States where the building shall be executed as well as the manufacturer's information shall be taken into account.

### **A3.3 Installation**

The execution of the construction works shall be performed according to the manufacturer's information. The manufacturer hands over the assembling instruction which includes all necessary aspects regarding the works to the executing company.

Where relevant, the requirements of EN 1090-2 shall be taken into account.

It is indicated in the assembling instruction that all SEH® units must be checked before installation for perfect quality and that damaged building elements may not be used.

The compatibility of the completed building with the provisions of the European Technical Assessment is confirmed by the executing company.

The completed building (the construction works) shall comply with the building regulations (provisions on the construction works) applicable in the Member States where the building shall be constructed.

The procedures which are foreseen in the Member States to verify the conformity with the building regulations shall be taken into account. A European Technical Assessment for prefabricated building units does not amend this process in any way.

Deflection criteria should not be exceeded during transportation or installation.

#### **A3.4 Transport and storage**

The manufacturer's specifications concerning transport and storage shall be taken into account. The instructions should specify special measures for protection against the effects of weather, which can cause damage to components and/or the complete building unit.

#### **A3.5 Maintenance and repair**

With regard to the assumed working life, a regular maintenance is required. The manufacturer must attach documents in written form which include information concerning type and frequency of the maintenance. The manufacturer's instructions shall be taken into account.